

# A80R

## MANUALE D'ISTRUZIONE GENERAL INSTRUCTION BOOK

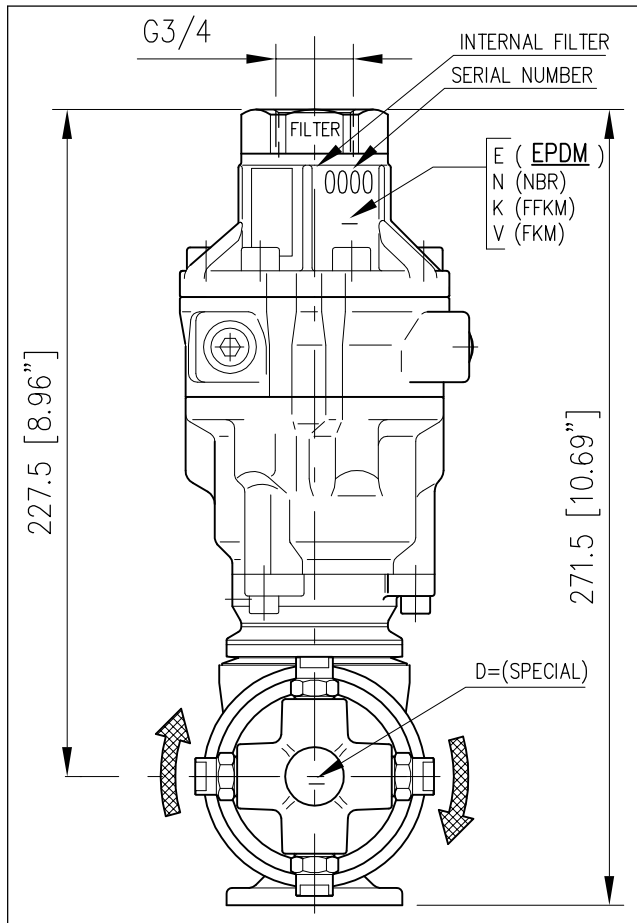

Foro entrata minimo  
in manuale  
Minimum inlet hole  
for manual operation

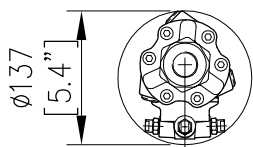

Foro entrata minimo  
in automatico  
Minimum inlet hole  
for automatic operation

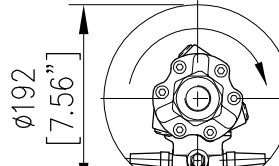
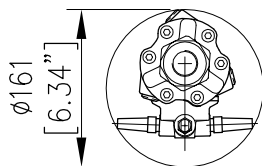
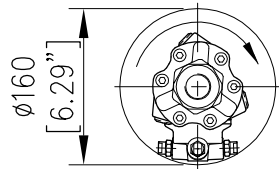

### TESTINA AUTOMOVENTE PER PULIZIA CISTERNE

- Testina volumetrica, la velocità di rotazione è proporzionale alla portata in ingresso.
- Lavaggio superfici interne di contenitori e serbatoi.
- Portata ridotta, alta pressione, elevata forza di impatto.
- Copertura orbitale completa degli interni.
- Velocità di rotazione indipendente dalla temperatura dell'acqua.
- Filtro in entrata.
- Costruzione in acciaio inox.
- Idonea per impiego settore alimentare.

### ATTENZIONE !

- La Testina STANDARD è fornita di guarnizioni (DINAMICHE) in PTFE + O-Ring **EPDM**.
- Lubrificare esclusivamente con **GRASSO SILICONICO** codice: 14.6552.00
- Per l'utilizzo di liquidi detergenti, additivi chimici ecc. non compatibili con le guarnizioni standard è indispensabile contattare il nostro UFFICIO TECNICO.
- A richiesta le guarnizioni (DINAMICHE) O-RING sono disponibili anche in diverso materiale, NBR-FFKM(kalrez)-FKM(viton).
- Le guarnizioni (STATICHE) sono in FKM (viton).

### SELF ROTATING CLEANING HEAD

- This is a self-propelled tank cleaning head: when the flow rate increases, the head rotates faster.
- Cleaning of interior surfaces of tanks and drums.
- Reduced flow, high pressure, high cleaning impact.
- Complete orbital coverage of all interior surfaces.
- Rotating speed independent from water temperature.
- Inlet filter.
- Stainless steel construction.
- Suitable for utilization in food industry.

### ATTENTION !

- The STANDARD Tank cleaning head is supplied with seals (DYNAMIC) in PTFE + O-Ring **EPDM**.
- Lubricate **ONLY** with **SILICONE GREASE** P/N: 14.6552.00
- For use with Detergent liquid, Chemical additives etc that are not compatible with the standard seals, it is essential to contact our TECHNICAL OFFICE for further information.
- On request, the O-RING seals (DYNAMIC) are available in different materials such as NBR-FFKM(kalrez)-FKM(viton).
- The STATIC seals are in FKM (viton).

ATTENZIONE: NON UTILIZZARE  
L'APPARECCHIO PRIMA DI AVER LETTO  
QUESTO MANUALE DI ISTRUZIONE

CAUTION: DO NOT USE THE  
CLEANING HEAD BEFORE HAVING READ  
THE INSTRUCTION BOOK

# CARATTERISTICHE TECNICHE TECHNICAL SPECIFICATIONS

A80-R



- PRESSIONE NOMINALE RATED PRESSURE	30÷140 bar - 3÷14 MPa (435-2000 psi)
- PRESSIONE CONSENTITA PERMISSIBLE PRESSURE	160 bar - 16 MPa (2300 psi)
- PORTATA MASSIMA MAX FLOW RATE	20 - 120 l/min (5.3-32 USGp.m.)
- TEMPERATURA MASSIMA ACQUA MAX WORKING TEMPERATURE	0-90°C (32-195°F)
- PESO WEIGHT	5.9 kg (208 oz)
- FREQUENZA ROTAZIONE ASSE PRINCIPALE MAIN AXIS ROTATING SPEED	10-16 giri/min (RPM)
- ATTACCO ALIMENTAZIONE ACQUA INLET CONNECTION SIZE	G 3/4"
- FILTRO IN INGRESSO INLET FILTER	550 µm
- ATTACCO UGELLI (2 o 4) NOZZLES CONNECTION (2 or 4)	1/4 NPT

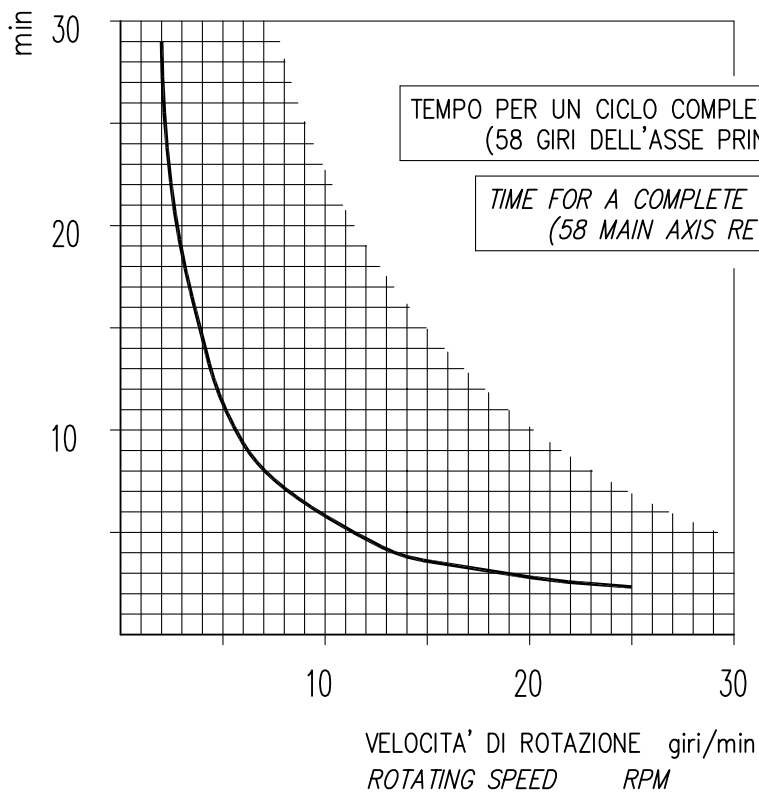

-D1-

VARIAZIONE DEI GIRI IN FUNZIONE DELLA PORTATA  
RPM VARIATION IN RELATION TO FLOW

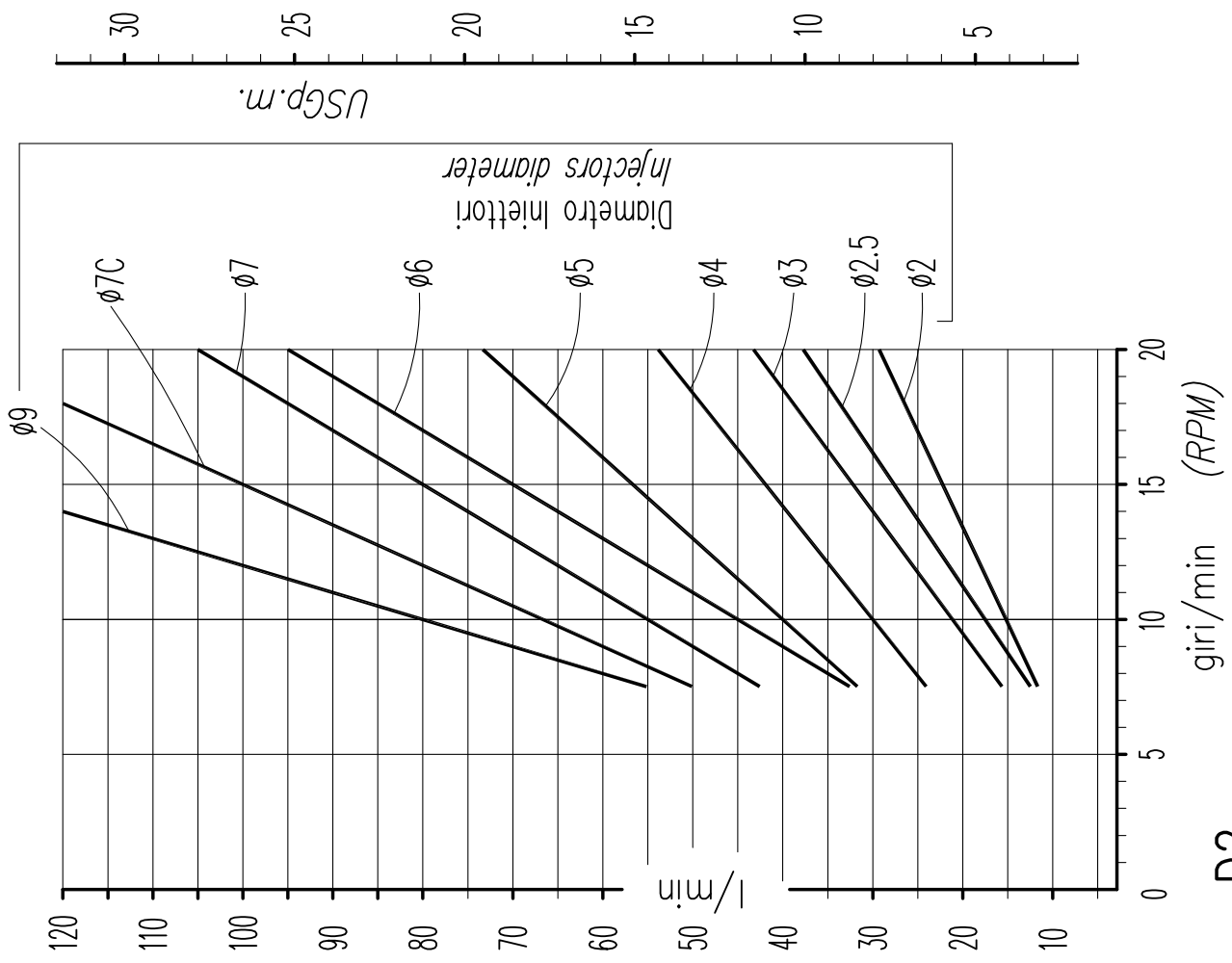

CADUTA DI PRESSIONE IN FUNZIONE DELLA PORTATA  
LOSS OF PRESSURE IN RELATION TO FLOW

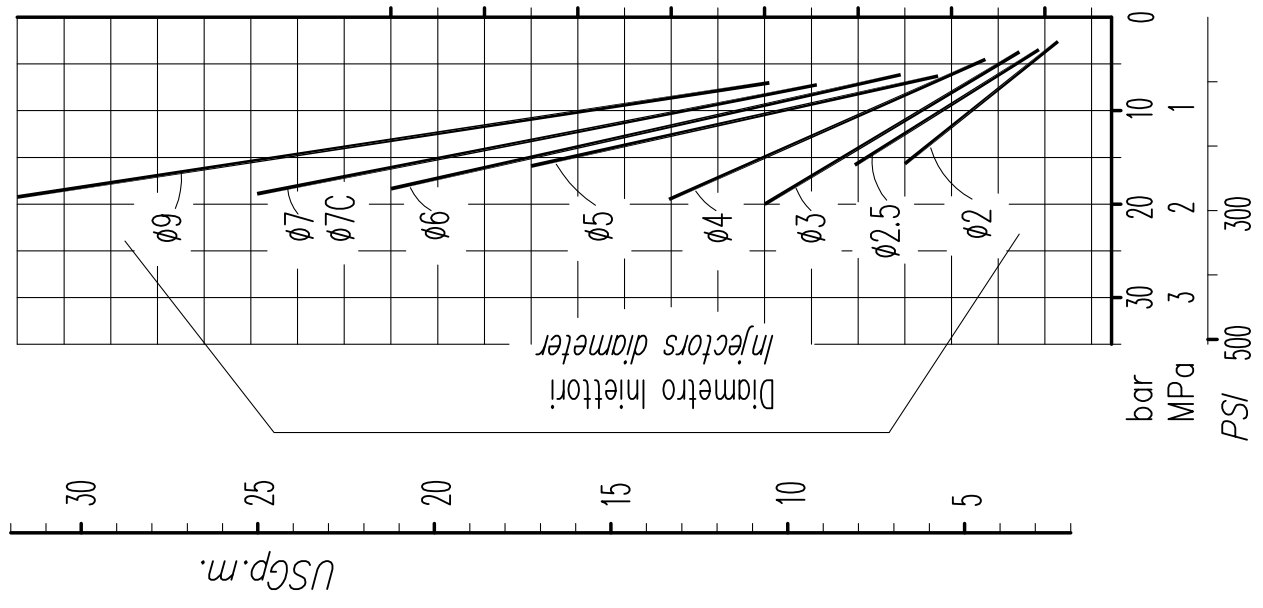



**P.A. – S.p.A. – EQUIPAGGIAMENTI TECNICI DEL LAVAGGIO**

VIA MILANO, 13 – CASELLA POSTALE 115 – 42048 RUBIERA (REGGIO EMILIA) – ITALY  
 Tel. +39 0522 623611 – Fax. +39 0522 629600 – R.E.A. RE 156319 – R.I. RE11535 – Mecc. RE 013446  
 C.F. e P. IVA 01035950359 – Cap. Soc. i.v. € 750.000,00 – Codice Identificativo C.E.E. IT 01035950359  
 ART. 2497 – BIS C.C. DIREZIONE E COORDINAMENTO BENETTI srl R.I. TRIB. DI RE 01480690351  
 Web: <http://www.pa-etl.it> – E-mail: [info@pa-etl.it](mailto:info@pa-etl.it)



**Dichiarazione di conformità – Declaration of conformity**

<b>Attrezzatura – Equipment:</b>		<b>ACCESSORIO A PRESSIONE PRESSURE EQUIPMENT</b>	
<b>Modello – Type:</b>		<b>A80R - A80R2</b>	
<b>Fluido – Fluid:</b>		<b>ACQUA CALDA E DETERGENTI HOT WATER AND DETERGENTS</b>	
<b>Gruppo fluidi: Group of Fluid:</b>	<b>II</b>	<b>Temperatura min. e max. ammissibile Permissible Temperature (min/max °C)</b>	<b>0 ÷ 90°C</b>

**Procedura di valutazione della conformità**

*Conformity Assessment Procedure Followed*

<b>Allegato: Annex:</b>		<b>Modulo: Module:</b>	
<b>Organismo notificato - Notified Body:</b>			-----
<b>Attestato CE del tipo - EC Type - Examination Certificate:</b>			-----
<b>Marcatura CE del fabbricante - Manufacturer's CE Marking:</b>			-----
<b>Organismo Notificato per il Sistema Qualità: Notified Body for Assessment of Quality System:</b>			-----
<b>Organismo di certificazione per il Sistema di Qualità: Notified Body for Certification of Quality System:</b>			<b>DNV-GL</b>
<b>Norme europee applicate: Harmonized Standards applied :</b>			<b>CEI EN 60335-2-79:2015 UNI EN 1829-1:2010</b>
<b>Codici di calcolo: Design Calculations Applied:</b>			

<b>Libretto uso e manutenzione presente nel sito web Operation and Maintenance Manual available on Website</b>	<b>Il Fabbricante PA SpA The Manufacturer PA SpA</b>	
--	--	--

25.4820.20 A80R Test.semov.iniett.2mm  
 25.4820.25 A80R Test.semov.iniett.2,5mm  
 25.4820.30 A80R Test.semov.iniett.3mm  
 25.4820.40 A80R Test.semov.iniett.4mm  
 25.4820.50 A80R Test.semov.iniett.5mm  
 25.4820.60 A80R Test.semov.iniett.6mm  
 25.4820.70 A80R Test.semov.iniett.7mm

25.4820.80 A80R Test.semov.iniett.7mm corto  
 25.4820.90 A80R Test.semov.iniett.9mm  
 25.4825.25 A80R testina, iniett.2,5mm, ug.diritti  
 25.4825.60 A80R testina, iniett.6mm, ug.diritti  
 25.4825.70 A80R testina, iniett.7mm, ug.diritti  
 25.4826.60 A80R/6mm Testina ug.diritti-Viton

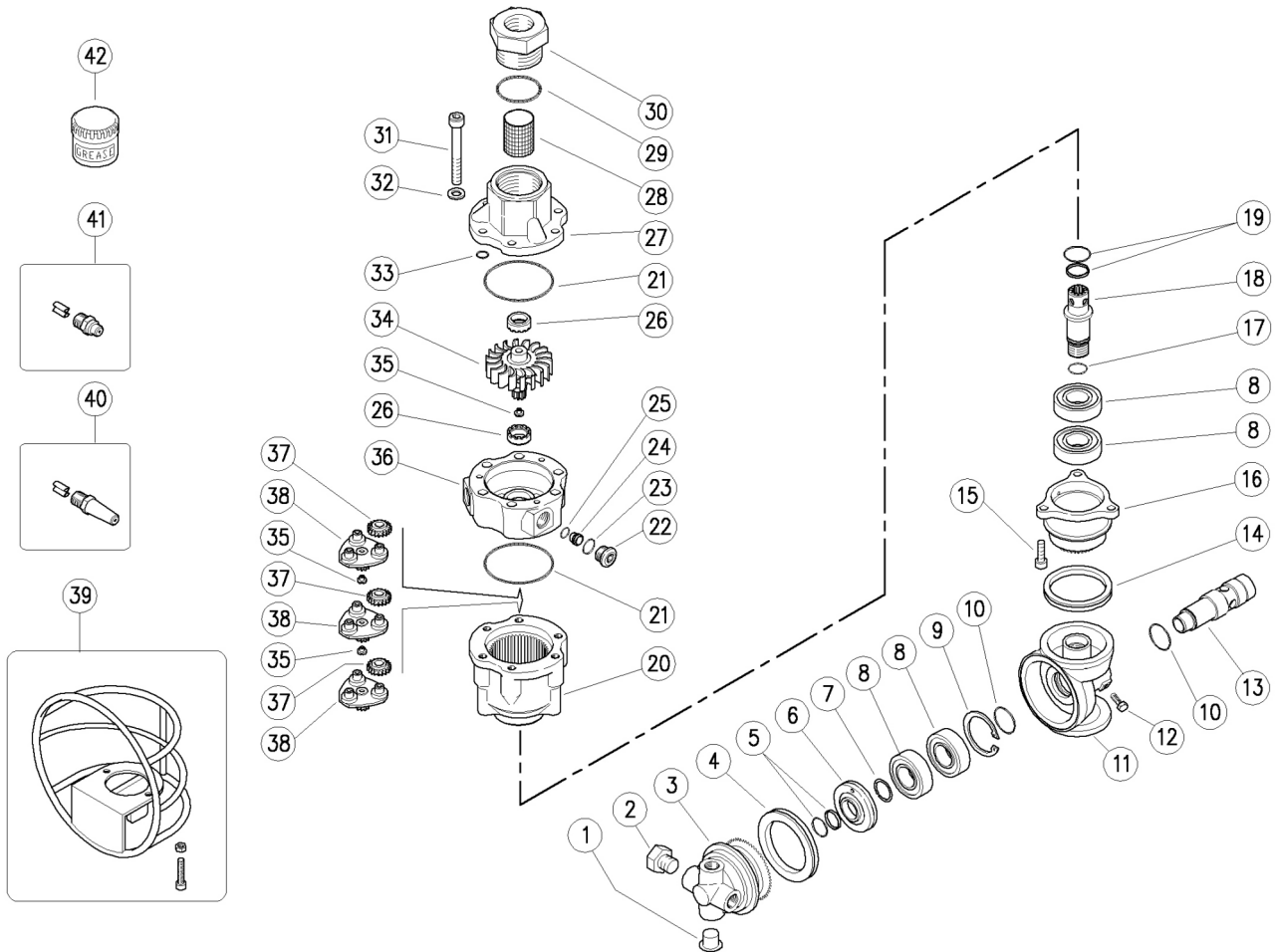

Pos.	Codice	Descrizione	Q.tà	K1	K2	K3	K4	
1	15.3720.14R	Tappo G1/4" plast.	2					4
2	15.3721.14R	Tappo inox 1/4M Npt s/testa	2					10
3	80.0132.52R	Pignone portaugelli z.58 4x1/4Npt F inox	1					1
3	80.0134.52R	Pignone p-ug. dir. z.58 4x1/4Npt F inox (1)	1					1
3	80.0134.52R	Pignone p-ug. dir. z.58 4x1/4Npt F inox (2)	1					1
4	10.2060.05R	Anello V-ring 54x5 mm	1	•				5
5	10.2030.16R	Guarn. stelo 16x21x2,2 mm +OR Epdm	1	•				5
5	10.2035.16R	Guarn.16x21x2,1 mm +Or Vit. (2) **	1					5
5	10.2033.16R	Anello guarn.16mm+An.Or, kalrez **	1					1
6	80.0211.51R	An. distanziale 16x41,8x8,8mm inox	1					5
7	10.1021.00R	An. elastico d.20x2 mm inox	1	•				10
8	11.4420.42R	Cuscinetto 20x42x12 mm - 2RS1 inox	4	•				2
9	10.1025.05R	An. elast. I 42 inox	1	•				5
10	10.3200.10R	An.OR 2,62x23,47 mm Vi 70	2	•				10
11	80.0135.52R	Terminale albero dentato inox	1					1
12	16.1870.02R	Vite DIN933 M5x12 mm inox	2					10
13	80.0242.51R	Perno 24x85mm inox	1					1
14	10.2050.05R	Anello V-ring 45x5 mm	1	•				2
15	16.1896.20R	Vite DIN912 M6x20 mm inox	3					10
16	80.0131.52R	Pignone z.39 inox	1					1
17	10.3066.10R	An.OR 1,78x15,6 mm Vi 70	1					10
18	80.0243.51R	Albero terminale inox	1					1
19	10.2030.18R	Guarn. stelo 18x23x2 mm +OR Epdm	1	•				5
19	10.2035.18R	Anello guarn.18mm -patt.+An.Or vit. (2) **	1					2
19	10.2033.18R	Anello gu.18mm -pat.+An.Or, kalrez **	1					1
20	80.0207.52R	Corona z.50 inox	1					1
21	10.3080.58R	An.OR 1,78x56,87 mm Vi 70	2	•				10
22	80.0219.51R	Tappo El M14x1 inox	3		•			3
23	10.3060.10R	An.OR 1,78x12,42 mm Vi 70	3	•	•			10
24	80.0221.51R	Iniettore 2mm inox (3) **	3					3

Pos.	Codice	Descrizione	Q.tà	K1	K2	K3	K4	
24	80.0227.51R	Iniettore 2,5mm inox (4) **	3					3
24	80.0222.51R	Iniettore 3mm inox (5) **	3					3
24	80.0223.51R	Iniettore 4mm inox (6) **	3			•		3
24	80.0224.51R	Iniettore 5mm inox (7)	3					3
24	80.0225.51R	Iniettore 6mm inox (8) **	3					3
24	80.0226.51R	Iniettore 7mm inox (9) **	3					3
24	80.0228.51R	Iniettore corto 7mm inox (10) **	3					3
25	10.3003.00R	An.OR 1x8 mm	3	•		•		10
26	80.0212.84R	Boccola plastica	2		•			10
27	80.0201.52R	Collettore inox	1					1
28	28.0014.53R	Rete 38mesh-400µm inox	1					10
29	10.3208.36R	An.OR 2,62x36,17 mm Vi 70	1	•				5
30	80.0217.51R	Racc. M40x2 M -G3/4F inox	1					1
31	16.1955.60R	Vite DIN912 M8x60 mm inox	6					10
32	14.3573.00R	Rosetta sicur. 8,4x2 mm inox	6					10
33	10.3109.93R	An.OR 2,4x8,3 mm Vi 70	3	•				10
34	80.0203.52R	Turbina inox	1					1
35	80.0213.84R	Perno rasamento plast.	3	•				10
36	80.0202.52R	Statore inox	1					1
37	80.0204.38R	Satellite z.19 bronzo	9	•				9
38	80.0205.00R	Portasatelliti+3 perni inox	3					1
39	25.4822.00R	Protez. -A80 R -ug.prolun. **	1					1
40	80.0418.23R	Ug. prol. inox 07 1/4M Npt+ventol. **	2-4					2
40	80.0420.23R	Ug. prol. inox 09 1/4M Npt+ventol. **	2-4					2
40	80.0430.23R	Ug. prol. inox 20 1/4M Npt +ventol. **	2-4					2
40	80.0440.23R	Ug. prol. inox 30 1/4M Npt +ventol. **	2-4					2
41	16.1380.45R	Ug. inox 1/4M Npt+ventol. 00.045 ***	2-4					10
42	14.6552.00R	Grass.silicone-teflon-30g.>tutti imp. **	1					2
42	14.6550.00R	Grasso al teflon x30 g.>no Epdm **	1					2

\*\* Su richiesta

\*\*\* Varie misure disponibili

Kit	Codice	Descrizione	
K1	25.4828.24	Kit ric.guarn. A80R 10x1pz.	1
K2	25.4852.24	Kit ric. A80R 7x1pz.	1
K3	25.4810.40	A80 kit iniettori 4,00mm+tappi	1

(1) 25.4825.25 (2) 25.4826.60 (3) 25.4820.20 (4) 25.4820.25 (5) 25.4820.30 (6) 25.4820.40 (7) 25.4820.50 (8) 25.4820.60 (9) 25.4820.70 (10) 25.4820.80

- 25.4820.20 A80R Tank clean.,s/prop.,2mm inject.
- 25.4820.25 A80R Tank clean.,s/prop.,2,5mm inject.
- 25.4820.30 A80R Tank clean.,s/prop.,3mm inject.
- 25.4820.40 A80R Tank clean.,s/prop.,4mm inject.
- 25.4820.50 A80R Tank clean.,s/prop.,5mm inject.
- 25.4820.60 A80R Tank clean.,s/prop.,6mm inject.
- 25.4820.70 A80R Tank clean.,s/prop.,7mm inject.

- 25.4820.80 A80R Tank clean.,s/prop.,7mm short inj.
- 25.4820.90 A80R Tank clean.,s/prop.,9mm inject.
- 25.4825.25 A80R Tank cl.,2,5mm inject,strght nozzl.
- 25.4825.60 A80R Tank cl.,6mm inject,straight nozzl.
- 25.4825.70 A80R Tank cl.,7mm inject,straight nozzl.
- 25.4826.60 A80R/6mm Clean.head,strgt.nozzles-Viton

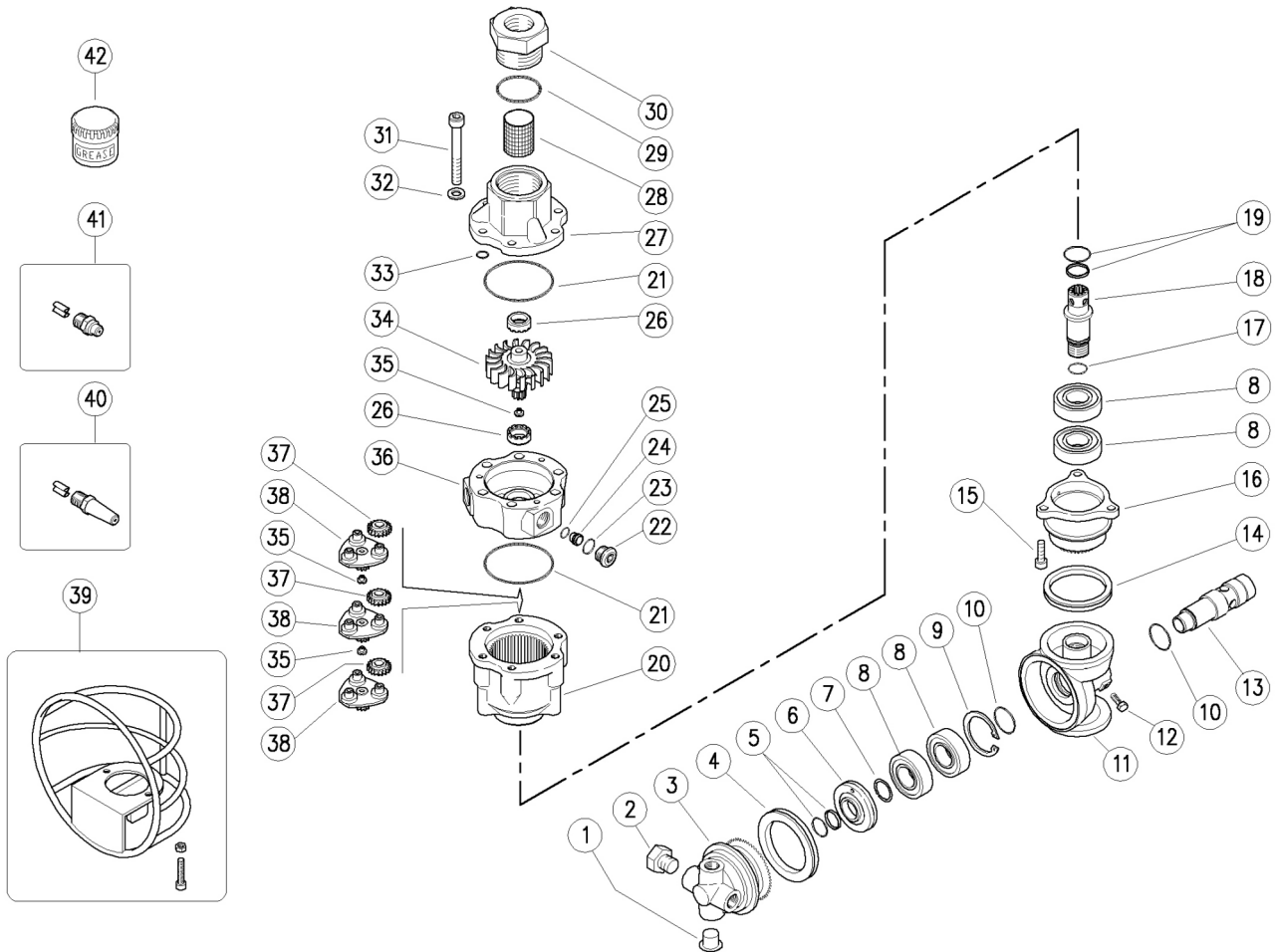

Pos.	P/N	Description	Q.ty	K1	K2	K3	K4	
1	15.3720.14R	Plug, 1/4" Bsp plast.	2					4
2	15.3721.14R	Grub screw, Sst. 1/4M Npt	2					10
3	80.0132.52R	Nzl hold. pinion, z.58 4x1/4Npt F Sst.	1					1
3	80.0134.52R	Strght.nzl hold.pinion,z.58 4x1/4Npt F (1)	1					1
3	80.0134.52R	Strght.nzl hold.pinion,z.58 4x1/4Npt F (2)	1					1
4	10.2060.05R	V-ring seal, 54x5 mm	1	•				5
5	10.2030.16R	Stem seal, 16x21x2,2 mm +O-ring Epdm	1	•				5
5	10.2035.16R	Seal, 16x21x2,1 mm+Or.iVit. (2) **	1					5
5	10.2033.16R	Seal,16mm+O-ring, kalrez **	1					1
6	80.0211.51R	Spacer ring, 16x41,8x8,8mm Sst.	1					5
7	10.1021.00R	Snap ring, d.20 mm Sst.	1	•				10
8	11.4420.42R	Ball-bearing, 20x42x12 mm - 2RS1 Sst.	4	•				2
9	10.1025.05R	Snap ring, l 42 Sst.	1	•				5
10	10.3200.10R	O-ring, 2,62x23,47 mm Vi 70	2	•				10
11	80.0135.52R	Geared shaft end, Sst.	1					1
12	16.1870.02R	Screw, DIN933 M5x12 mm Sst.	2					10
13	80.0242.51R	Pin, 24x85mm Sst.	1					1
14	10.2050.05R	V-ring seal, 45x5 mm	1	•				2
15	16.1896.20R	Screw, DIN912 M6x20 mm Sst.	3					10
16	80.0131.52R	Pinion, z.39 Sst.	1					1
17	10.3066.10R	O-ring, 1,78x15,6 mm Vi 70	1					10
18	80.0243.51R	Geared shaft, Sst.	1					1
19	10.2030.18R	Stem seal, 18x23x2 mm +O-ring Epdm	1	•				5
19	10.2035.18R	Seal, 18mm -slid.block +O-ring, vit. (2) **	1					2
19	10.2033.18R	Seal, 18mm -slid.block +O-ring, kalrez **	1					1
20	80.0207.52R	Ring gear, z.50 Sst.	1					1
21	10.3080.58R	O-ring, 1,78x56,87 mm Vi 70	2	•				10
22	80.0219.51R	Plug, int.hex., M14x1 Sst.	3		•			3
23	10.3060.10R	O-ring, 1,78x12,42 mm Vi 70	3	•	•			10
24	80.0221.51R	Injector, 2mm Sst. (3) **	3					3

Pos.	P/N	Description	Q.ty	K1	K2	K3	K4	
24	80.0227.51R	Injector, 2,5mm Sst. (4) **	3					3
24	80.0225.51R	Injector, 3mm Sst. (5) **	3					3
24	80.0223.51R	Injector, 4mm Sst. (6) **	3		•			3
24	80.0224.51R	Injector, 5mm Sst. (7)	3					3
24	80.0225.51R	Injector, 6mm Sst. (8) **	3					3
24	80.0226.51R	Injector, 7mm Sst. (9) **	3					3
24	80.0228.51R	Short injector, 7mm Sst. (10) **	3					3
25	10.3003.00R	O-ring, 1x8 mm	3	•		•		10
26	80.0212.84R	Bushing, plast.	2		•			10
27	80.0201.52R	Manifold, Sst.	1					1
28	28.0014.53R	Net, 38mesh-400µm Sst.	1					10
29	10.3208.36R	O-ring, 2,62x36,17 mm Vi 70	1	•				5
30	80.0217.51R	Coupl., M40x2 M -3/4F Bsp Sst.	1					1
31	16.1955.60R	Screw, DIN912 M8x60 mm Sst.	6					10
32	14.3573.00R	Safet. washer, 8,4x2 mm Sst.	6					10
33	10.3109.93R	O-ring, 2,4x8,3 mm Vi 70	3	•				10
34	80.0203.52R	Turbine, Sst.	1					1
35	80.0213.84R	Shim pin, plast.	3		•			10
36	80.0202.52R	Stator, Sst.	1					1
37	80.0204.38R	Planetary gear, z.19 brz	9		•			9
38	80.0205.00R	Planetary gear holder+3 pins, Sst.	3					1
39	25.4822.00R	Protect. -A80 R -extnd nzl. **	1					1
40	80.0418.23R	Xnd. nzl., sst. 07 1/4M Npt+guid.vane **	2-4					2
40	80.0420.23R	Xnd. nzl., sst. 09 1/4M Npt+guid.vane **	2-4					2
40	80.0430.23R	Xnd. nzl., sst. 20 1/4M Npt +guid.vane **	2-4					2
40	80.0440.23R	Xnd. nzl., sst. 30 1/4M Npt +guid.vane	2-4					2
41	16.1380.45R	Nzl, sst,1/4M Npt+guid.vane 00.045 ***	2-4					10
42	14.6552.00R	Teflon silicon grease x30g.>All **	1					2
42	14.6550.00R	Teflon grease x30g.>no Epdm **	1					2

\*\* On request

\*\*\* Different measures available

Kit	P/N	Description	
K1	25.4828.24	Seals Spares Kit - A80R 10x1pcs.	1
K2	25.4852.24	Spares Kit - A80R 7x1pcs.	1
K3	25.4810.40	A80 injector kit size 040, w/plug	1

(1) 25.4825.25 (2) 25.4826.60 (3) 25.4820.20 (4) 25.4820.25 (5) 25.4820.30 (6) 25.4820.40 (7) 25.4820.50 (8) 25.4820.60 (9) 25.4820.70 (10) 25.4820.80