

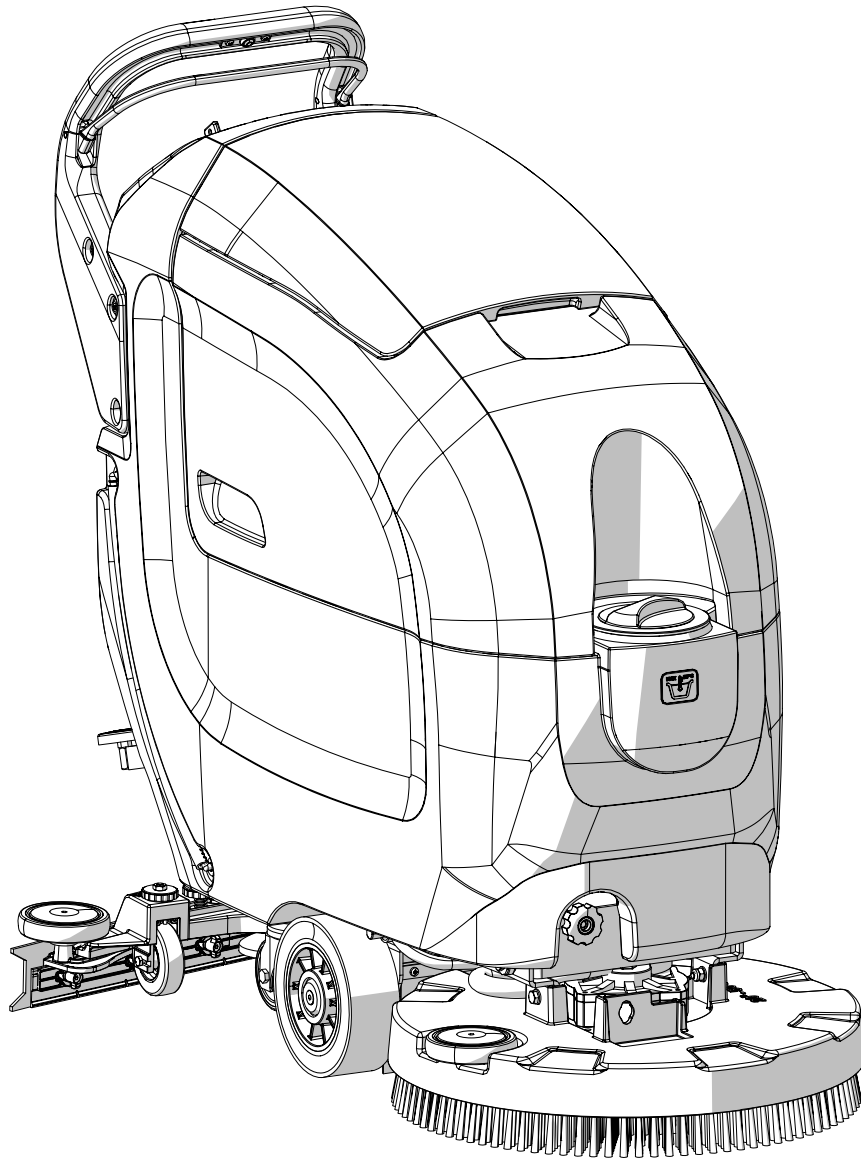

agila
bt



SCRUBBING MACHINES

USE AND MAINTENANCE MANUAL



CONTENTS

CONTENTS	3
LOCATION OF THE MAIN MACHINE COMPONENTS	5
GENERAL DESCRIPTION	6
GENERAL SAFETY REGULATIONS.....	6
SYMBOLS USED IN THE MANUAL.....	6
PURPOSE AND CONTENT OF THE MANUAL.....	7
TARGET GROUP.....	7
PRESERVATION OF THE USER.....	7
ON CONSIGNMENT OF THE MACHINE.....	7
INTRODUCTORY COMMENT.....	7
IDENTIFICATION DATA.....	7
TECHNICAL DESCRIPTION.....	7
INTENDED USE.....	7
SAFETY.....	7
REGULATIONS.....	7
SERIAL NUMBER PLATE.....	8
TECHNICAL DATA	8
SYMBOLS AND LABELS USED ON THE MACHINE	9
SYMBOLS USED ON THE MACHINE.....	9
LABELS USED ON THE MACHINE.....	9
SYMBOLS USED ON THE CONTROL PANEL.....	10
SYMBOLS USED ON THE CONTROL DISPLAY SCREENS.....	10
PREPARATION OF MACHINE	11
HANDLING THE PACKAGED MACHINE.....	12
HOW TO UNPACK THE MACHINE.....	12
HOW TO MOVE THE MACHINE.....	12
MACHINE SAFETY.....	13
TYPE OF BATTERY TO BE USED.....	13
INSERTING THE BATTERIES IN THE MACHINE.....	13
BATTERY MAINTENANCE AND DISPOSAL.....	13
RECHARGING THE BATTERIES.....	13
INSERTING WATER SYSTEM FILTER.....	14
ASSEMBLING THE BRUSH.....	14
ASSEMBLING THE SQUEEGEE BODY.....	15
FILLING THE SOLUTION TANK WITH WATER.....	15
DETERGENT SOLUTION.....	15
PREPARING TO WORK	16
STARTING WORK	17
HOUR METER.....	18
BATTERY CHARGE LEVEL INDICATOR.....	18
SCRUBBING WITH DRYING.....	18
SCRUBBING WITHOUT DRYING.....	18
SCRUBBING WITH DRYING.....	19
ADJUSTMENT OF THE DETERGENT SOLUTION FLOW.....	19
REGULATING THE FORWARD SPEED.....	19
REVERSE GEAR.....	19
ALARM SCREEN.....	20
ECO MODE.....	20
OVERFLOW DEVICE.....	20
AT THE END OF THE WORK	20
RECOMMENDED MAINTENANCE OPERATIONS	21
CLEANING THE SQUEEGEE BODY.....	22
CLEANING THE BRUSH HEAD BRUSH.....	22
DRAINING THE RECOVERY TANK.....	22
CLEANING THE SUCTION MOTOR FILTER.....	23
CLEANING THE VACUUM TUBE.....	23

EMPTYING THE SOLUTION TANK.....	23
CLEANING THE WATER SYSTEM FILTER.....	23
EXTRAORDINARY MAINTENANCE WORK	23
REPLACING THE SQUEEGEE BODY RUBBER BLADES	24
REPLACING THE BRUSH	24
ADJUSTMENT INTERVENTIONS.....	25
ADJUSTING THE SQUEEGEE BODY'S RUBBER BLADES	25
BRUSHES AND BRUSH PAD HOLDER.....	26
DISPOSAL	26
TROUBLESHOOTING	26
EC DECLARATION OF CONFORMITY	28

LOCATION OF THE MAIN MACHINE COMPONENTS

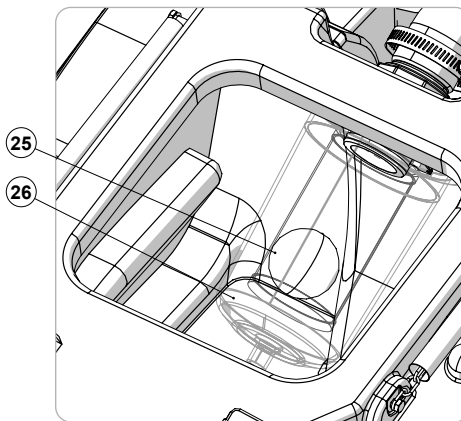
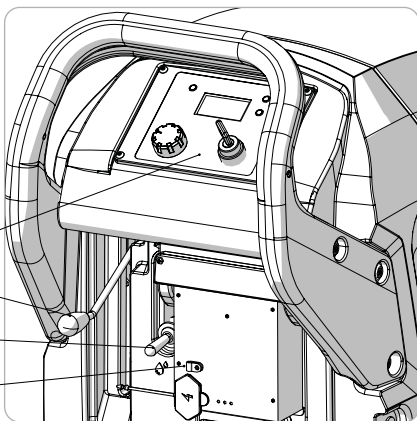
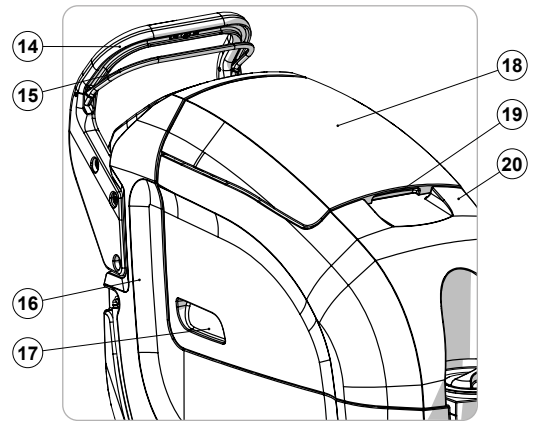
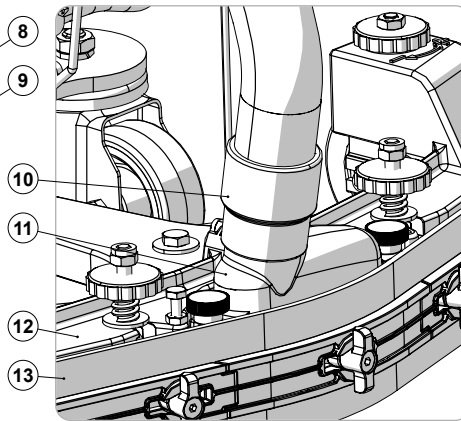
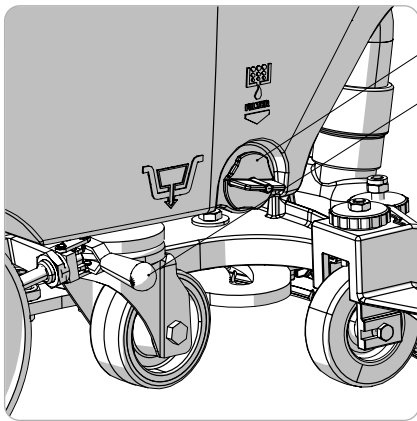
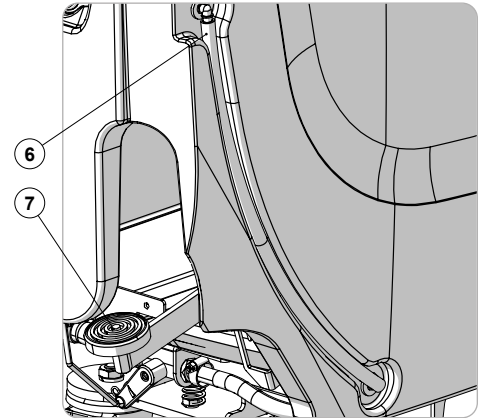
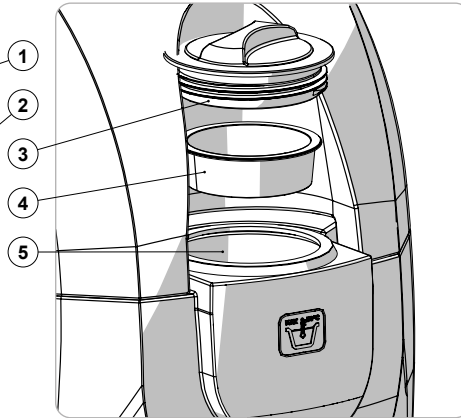
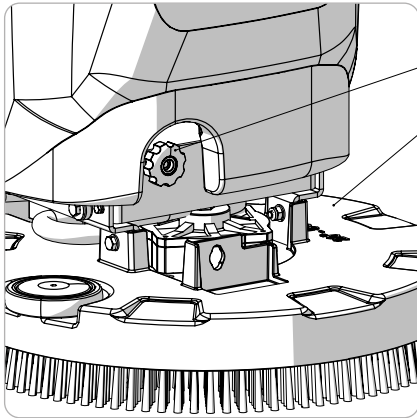

The machine's main components are the following:

1. Brush head tilt adjustment knob.
2. Brush head body.
3. Solution tank filler hole cap.
4. Solution tank filler hole filter.
5. Solution tank filler hole.
6. Detergent solution level tube.
7. Brush head control pedal.
8. Cap - Solution tank filter.
9. Parking brake.
10. Vacuum tube.
11. Vacuum nozzle.
12. Squeegee support.
13. Squeegee body.
14. Control handlebars.

15. Dead man's lever.
16. Solution tank.
17. Recovery tank lifting handle.
18. Recovery tank lid.
19. Recovery tank cover lifting handle.
20. Recovery tank.
21. Control panel.
22. Squeegee body lifting lever.
23. Detergent solution adjustment lever.
24. Battery charger (valid for CB versions).
25. Suction motor filter.
26. Suction motor filter cover cup.















GENERAL DESCRIPTION

The descriptions contained in this document are not binding. The company therefore reserves the right to make any modifications at any time to elements, details, or accessory supply, as considered necessary for reasons of improvement or manufacturing/commercial requirements. The reproduction, even partial, of the text and drawings contained in this document is prohibited by law. **The company reserves the right to make any technical and/or supply modifications. The images are shown as reference only and are not binding as to the actual design and/or equipment.**

GENERAL SAFETY REGULATIONS

Before using the machine, please read the following document carefully and follow the instructions contained herein, along with the instructions in the document supplied with the machine itself, "GENERAL SAFETY REGULATIONS" (document code 10083659).

SYMBOLS USED IN THE MANUAL

	Open book symbol with an "i": Indicates the need to consult the instruction manual.
	Open book symbol: Tells the operator to read the user manual before using the device.
	Covered place symbol: The operations preceded by this symbol must always be carried out in a dry, covered area.
	Information symbol: Indicates additional information for the operator, to improve the use of the device.
	Warning symbol: Carefully read the sections preceded by this symbol meticulously following the instructions indicated for the safety of the operator and the device.
	Danger symbol (corrosive substances): The operator should always wear protective gloves to avoid the risk of serious injury to the hands caused by corrosive substances.
	Danger symbol (battery acid leakage): Indicates the danger of leaking acid or acid fumes from the batteries while they are being recharged.
	Danger symbol (moving carriages): Indicates that the packed product should be handled with suitable carriages that conform to legal requirements.
	Mandatory room ventilation symbol: Informs the operator that the room must be ventilated while the batteries are being recharged.
	Symbol indicating the compulsory use of protective gloves: Indicates that the operator should always wear protective gloves, to avoid the risk of serious injury to his hands from sharp objects.
	Symbol indicating the compulsory use of tools: Informs the operator of the need to use tools not included with the machine.
	Symbol indicating a treading ban: Informs the operator that it is forbidden to tread on machine components, as this could lead to serious injury.
	Recycling symbol: Tells the operator to carry out the operations in compliance with environmental regulations in force in the place where the appliance is being used.
	Disposal symbol: Carefully read the sections marked with this symbol for disposing of the appliance.

PURPOSE AND CONTENT OF THE MANUAL

The aim of this manual is to provide customers with all the information needed to use the machine in the safest, most appropriate and most autonomous way. This includes information concerning technical aspects, safety, operation, downtime, maintenance, spare parts and scrapping. The operators and qualified technicians must carefully read the instructions in this manual before carrying out any operations on the machine. If in doubt about the correct interpretation of instructions, contact your nearest COMAC Customer Service Centre to obtain the necessary clarifications.

TARGET GROUP

This manual is written both for operators and for qualified machine maintenance technicians. Operators must not perform operations that should be carried out by qualified technicians. The manufacturer is not liable for damages resulting from failure to comply with this veto.

PRESERVATION OF THE USER

The Use and Maintenance Manual must be stored in its special pouch close to the machine, protected from liquids and anything else that could compromise its legibility.

ON CONSIGNMENT OF THE MACHINE

When the machine is consigned to the customer, an immediate check must be performed to ensure all the material mentioned in the shipping documents has been received, and also to check the machine has not suffered damage during transportation. If this is the case, the carrier must ascertain the extent of the damage at once, informing our customer service office. It is only by prompt action of this type that the missing material can be obtained, and compensation for damage successfully claimed.

INTRODUCTORY COMMENT

Any floor scrubbing machine can only work properly and effectively if used correctly and kept in full working order by performing the maintenance operations described in the attached documentation. We therefore suggest you read this instruction booklet carefully and read it again whenever difficulties arise while using the machine. If necessary, remember that our assistance service (organised in collaboration with our dealers) is always available for advice or direct intervention.

IDENTIFICATION DATA

For technical assistance or to request replacement parts, always give the model, the version and the serial number (written on the relevant plate).

TECHNICAL DESCRIPTION

The **Agila Bt** is a floor scrubbing machine that can work on various types of floor and dirt thanks to the mechanical action of a brush and the chemical action of a water-detergent solution. As it advances, it collects the dirt removed, along with the detergent solution not absorbed by the flooring itself. **The machine must only be used for this purpose.**

INTENDED USE

This scrubbing machine was designed and built for the cleaning (scrubbing and drying) of smooth, compact flooring in the commercial, residential and industrial sectors by a qualified operator in proven safety conditions. The scrubbing machine is not suitable for cleaning rugs or carpet floors. It is only suitable for use in closed (or at least covered) places.



ATTENTION: the machine is not suitable for use in the rain, or under water jets.



IT IS FORBIDDEN to use the machine in environments with an explosive atmosphere to clean dangerous powders or flammable liquids. In addition, it is not suitable as a means of transport for people or objects.

SAFETY

Operator cooperation is paramount for accident prevention. No accident prevention programme can be effective without the full cooperation of the person directly responsible for machine operation. The majority of occupational accidents that happen either in the workplace or whilst moving are caused by failure to respect the most basic safety rules. An attentive, careful operator is most effective guarantee against accidents and is fundamental in order to implement any prevention programme.

REGULATIONS

All references to forwards and backwards, front and rear, right and left indicated in this manual should be understood as referring to the operator in a driving position with his hands on the steering wheel.

SERIAL NUMBER PLATE

The serial number plate is positioned inside the machine, above the electrical system cover carter. It indicates the general machine characteristics, in particular the serial number. The serial number is a very important piece of information and should always be provided together with any request for assistance or when purchasing spare parts. The serial number plate contains the following:

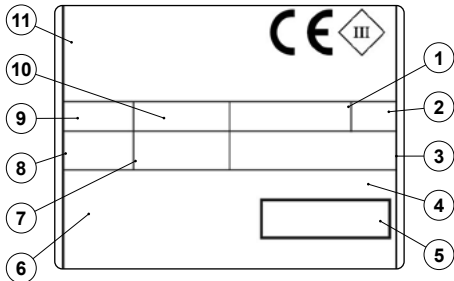
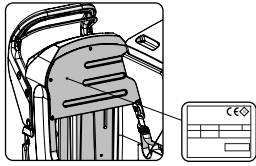

1. The weight of the batteries used to power the appliance (expressed in Kg).
2. The IP protection rating of the appliance.
3. The gross weight of the appliance (expressed in Kg).
4. The identification code of the appliance.
5. The serial number of the appliance.
6. The name of the appliance.
7. The nominal power consumed by the appliance (expressed in W).
8. The maximum grade that the appliance can handle during work activities (expressed in %).
9. The year in which the appliance was manufactured.
10. The nominal voltage of the appliance (expressed in V).
11. The commercial name of the appliance and the manufacturer's address.

TECHNICAL DATA

TECHNICAL DATA	U/M [KMS]	Agila 40-43 Bt	Agila 40-50 Bt	Agila 50-50 Bt
Rated machine power	kW	1,13	1,13	1,13
Theoretical working capacity up to	m ² /h	1590	1590	1590
Working width [IEC 62885-9]	mm	430	510	510
Squeegee width	mm	703	703	703
Drying track [IEC 62885-9]	mm	725	725	725
Total width of brushes [IEC 62885-9]	mm	1xØ430	1xØ510	1xØ510
Nominal power of brush motor/s [IEC 62885-9]	W	500	500	500
Free brush rotations	rpm	140	140	140
Maximum pressure exerted by brushes on floor	N/cm ²	0.2	0.2	0.2
Nominal power of traction motor [IEC 62885-9]	W	150	150	150
Maximum slope during work (GVW)	%	7	7	7
Maximum transfer speed [IEC 62885-9]	km/h	4	4	4
Nominal power of vacuum motor/s [IEC 62885-9]	W	480	480	480
Maximum vacuum [IEC 62885-9; IEC 60312-1]	KPa	8,79	8,79	8,79
Maximum solution tank capacity	l	36	36	49
Maximum recovery tank capacity	l	59	59	65
Machine dimensions during transport [IEC 62885-9]	mm	591	591	591
Machine dimensions (length - height - width)	mm	1183 1035 725	1183 1035 725	1183 1035 725
Battery compartment dimensions (length - height - width)	mm	355 290 365	355 290 365	355 290 365
Machine weight when empty	kg	75	75	75
Transported machine weight	kg	135	135	135
GVW	kg	175	175	175
Sound pressure level in operator seat [ISO 11201] (L _{PA})	dB	<70	<70	<70
Sound power level [IEC 60335-2-72; IEC 62885-9; ISO 3744] (L _{WA})	dB	<80	<80	<80
Uncertainty K _{PA}	dB	±1,5	±1,5	±1,5
Hand-arm vibrations [IEC 60335-2-72; IEC 62885-9; ISO 5349-1]	m/s ²	<2.5	<2.5	<2.5
Vibration measurement uncertainty		±4%	±4%	±4%
IP test [IEC 60335-2-72; IEC 60529]		IP 23	IP 23	IP 23

SYMBOLS AND LABELS USED ON THE MACHINE

SYMBOLS USED ON THE MACHINE

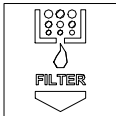

Filter body position symbol:

Applied to the left-hand side of the machine to indicate the position of the solution tank's filter.



Solution tank drainage cap symbol:

Applied to the left-hand side of the machine to identify the position of the solution tank drain cap.



Recovery tank drainage hose symbol:

Applied to the left-hand side of the machine to identify the position of the recovery tank drain tube.



Symbol for maximum temperature for filling the solution tank:

Located on the front of the machine to indicate the maximum temperature of the water for filling the solution tank safely.



Symbol indicating tap control lever position open for full flow:

Used on the rear right area of the machine to indicate how the tap control lever should be positioned to enable the maximum flow of the detergent solution.

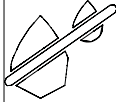

Symbol indicating tap control lever position for flow shut-off:

Used on the rear right area of the machine to indicate how the tap control lever should be positioned to shut off the flow of the detergent solution.

LABELS USED ON THE MACHINE



Label indicating the need to read the Use and Maintenance Manual:

Used above the recovery tank near the control handlebar to instruct the operator to read the use and maintenance manual before using the machine.



Label indicating the need to read the Use and Maintenance Manual:

Used on the rear part of the machine, near the squeegee control lever, to instruct the operator to read the use and maintenance manual before using the machine.



Machine use warning label:

Used on the rear part of the machine, near the squeegee control lever, to inform the operator that vacuuming/collecting flammable and/or explosive dust and/or liquids or incandescent particles is strictly forbidden.



Water system filter maintenance label:

Used on the left side of the machine, to instruct the operator to clean the water system filter after each work cycle.



Label warning about the risk of crushed hands:

Used inside the machine above the solution tank, near the recovery tank lifting handle, to inform the operator of the risk of damage to the hands due to crushing between two surfaces.



Warning during battery charging label:

Used inside the machine above the recovery tank, near the batteries, to instruct the operator to take care when performing the battery charge cycle.



Battery charging sequence label (versions without Battery Charger):

Used inside the machine above the recovery tank, near the batteries, to inform the operator of the sequence to be followed in order to charge the batteries correctly.



Battery charging sequence label (versions with battery charger):

Used inside the machine above the recovery tank, near the batteries, to inform the operator of the sequence to be followed in order to charge the batteries correctly.

SYMBOLS USED ON THE CONTROL PANEL

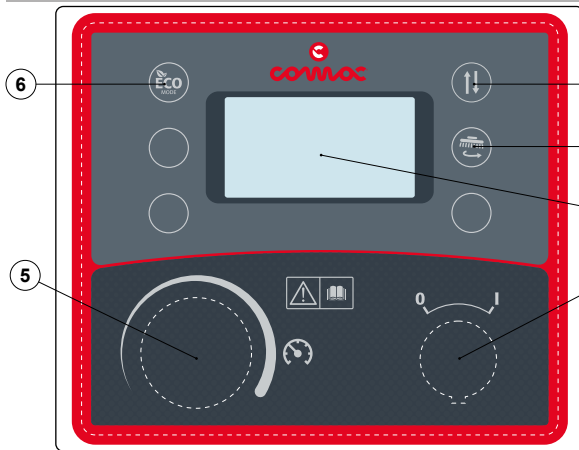

The control screen is divided in:

1. Symbol of the reverse movement selector: indicates the switch that enables the reverse function to be activated.
2. Brush release symbol: indicates the switch that enables the brush uncoupling function to be activated.
3. Control display: is a digital display that enables the parameters set in the machine during its use to be viewed.
4. Machine main switch symbol: indicates the key switch that enables the machine to be activated or deactivated.
5. Traction motor potentiometer symbol: indicates the knob that enables the potentiometer associated with the traction motor to be adjusted.
6. Symbol for ECO-MODE program: indicates the switch that enables the ECO-MODE working mode to be activated.

SYMBOLS USED ON THE CONTROL DISPLAY SCREENS



The adjacent image identifies the WORK PANEL screen, the icon in the top right corresponds to the charge level of the batteries.

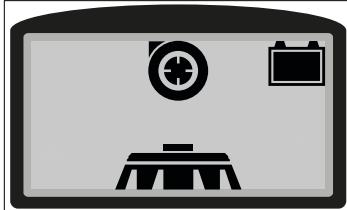

The adjacent image identifies the SCRUBBING WITH DRYING work screen with the STANDARD working mode active. The symbol in the middle of the screen identifies the type of work being carried out. In this case, both the brush head unit and the squeegee unit are in contact with the ground.

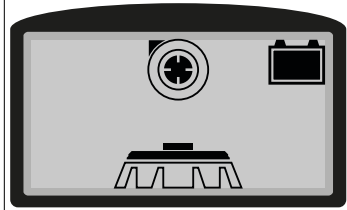

The adjacent image identifies the SCRUBBING WITH DRYING work screen with the ECO-MODE working mode active. The symbol in the middle of the screen identifies the type of work being carried out. In this case, both the brush head unit and the squeegee unit are in contact with the ground.

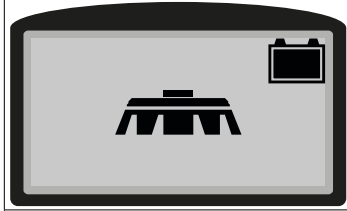

The adjacent image identifies the SCRUBBING WITHOUT DRYING work screen with the STANDARD working mode active. The symbol in the middle of the screen identifies the type of work being carried out. In this case, only the brush head body is in contact with the ground.

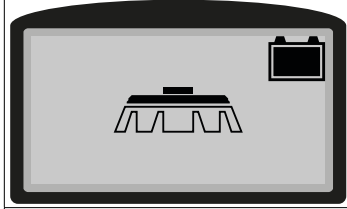

The adjacent image identifies the SCRUBBING WITHOUT DRYING work screen with the ECO-MODE working mode active. The symbol in the middle of the screen identifies the type of work being carried out. In this case, only the brush head body is in contact with the ground.

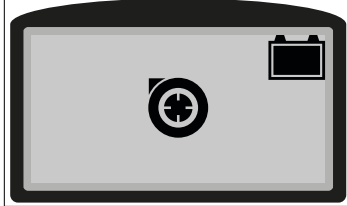

The adjacent image identifies the DRYING work screen with the STANDARD working mode active. The symbol in the middle of the screen identifies the type of work being carried out. In this case, only the brush head body is in contact with the ground.

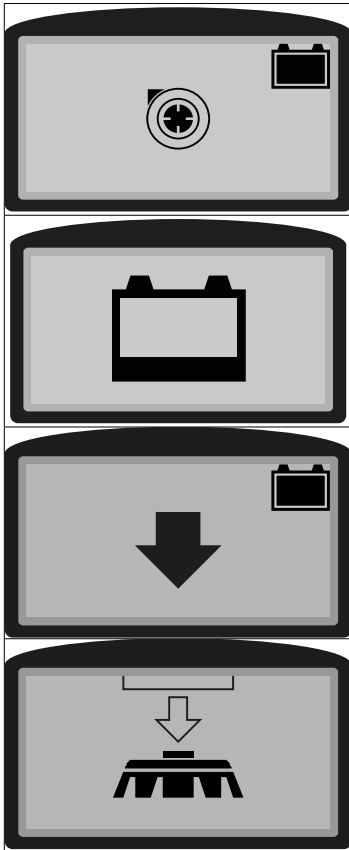

The adjacent image identifies the DRYING work screen with the ECO-MODE working mode active. The symbol in the middle of the screen identifies the type of work being carried out. In this case, only the brush head body is in contact with the ground.

The adjacent image shows the CRITICAL BATTERY CHARGE LEVEL warning screen. The symbol in the middle of the screen indicates that the battery charge has reached a critical level. The remaining charge is sufficient for completing the drying task before recharging the batteries.

The adjacent image indicates that REVERSE is engaged. The symbol in the middle of the screen indicates that reverse movement is currently being used.

The adjacent image indicates BRUSH RELEASE. The symbol in the middle of the screen indicates the activation of the sequence for releasing the brush from the brush-holder plate on the brush head.

PREPARATION OF MACHINE

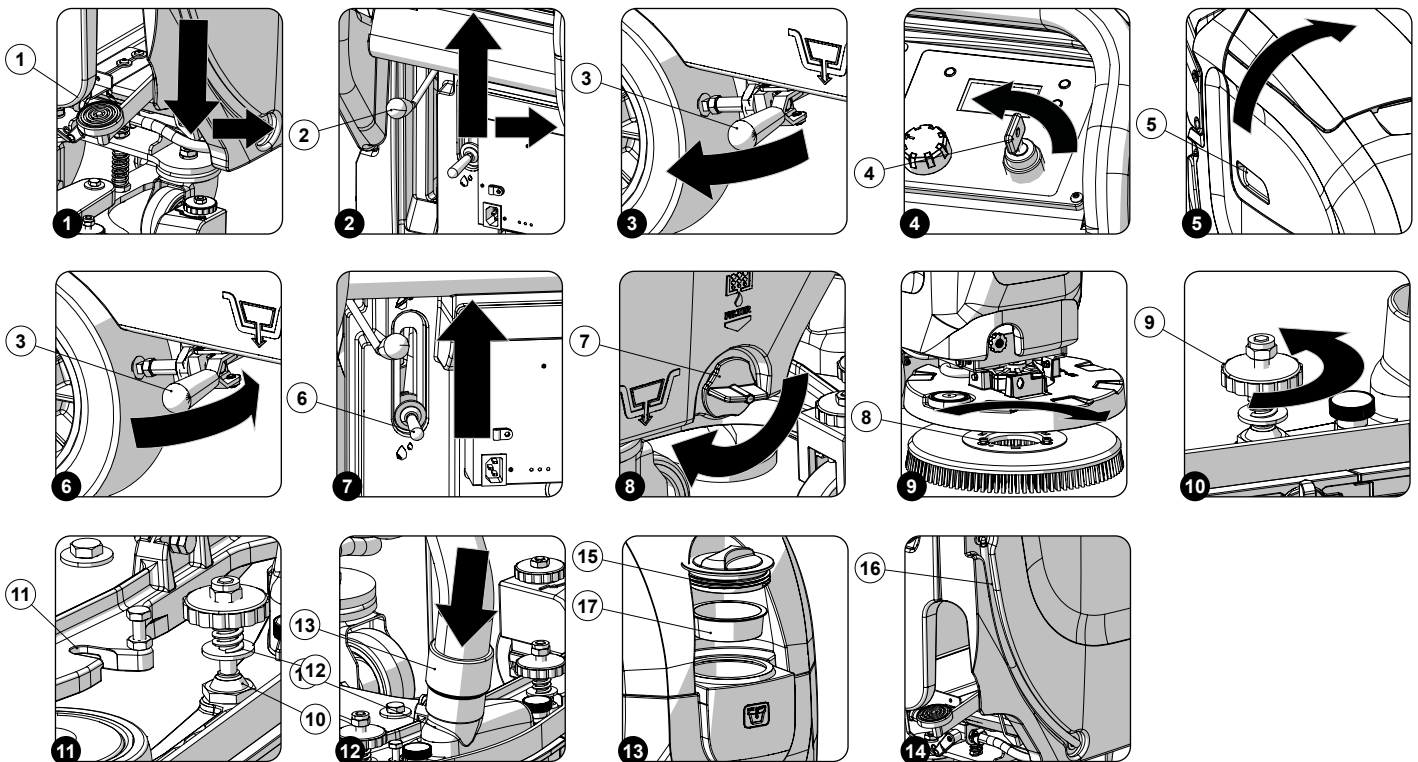

HANDLING THE PACKAGED MACHINE

The machine's overall weight including packaging is 000Kg.

The overall dimensions of the package are: Length = 000cm Width = 000cm Height = 000cm

 **ATTENTION:** It is recommended that all the packaging components be kept for any future machine transportation.

 **ATTENTION:** Move the packaged product with handling equipment that complies with legal requirements regarding the size and mass of the packaging.

HOW TO UNPACK THE MACHINE

The machine is shipped in specific packaging. To remove it, proceed as follows:

1. Place the lower part of the outer packaging in contact with the floor.

 **N.B.:** Use the pictograms printed on the box as reference.

2. Remove the outer package.

 **CAUTION:** It is recommended to wear the appropriate PPE (Personal Protective Equipment), suitable for the work to be carried out.

3. Raise the brush head body and press the brush head control pedal (1) (on the rear of the machine) downwards (**Fig.1**).
4. Raise the squeegee body and move the squeegee control lever (2) upwards (**Fig.2**). The lever is located on the back of the machine.
5. The machine is fixed to the pallet by means of chocks, which block the wheels and brush head; remove these chocks.
6. Go to the rear left area of the machine and disengage the parking brake, turn the lever (3) clockwise (**Fig.3**).
7. Use a ramp to bring the machine down from the pallet.

 **N.B.:** do not fit the brush and the rear squeegee body before unloading the machine, and avoid any violent jolts to the brush head and squeegee support.

HOW TO MOVE THE MACHINE

To transport the machine safely, proceed as follows:

1. Check to make sure that the solution tank and the recovery tank are empty. If this is not the case, empty them (see the sections titled "[EMPTYING THE SOLUTION TANK](#)" and "[EMPTYING THE RECOVERY TANK](#)").
2. Check that the machine is off; if this is not the case, set the main switch (4) to position "0" by turning the key a quarter turn anti-clockwise (**Fig.4**). As soon as the machine is off, remove the key from the control panel.
3. Raise the brush head body and press the brush head control pedal (1) (on the rear of the machine) downwards (**Fig.1**).
4. Raise the squeegee body and move the squeegee control lever (2) upwards (**Fig.2**). The lever is located on the back of the machine.
5. Use a ramp to move the machine up onto the transport vehicle.

 **CAUTION:** during this operation, check there are no people or objects near the machine.

 **N.B.:** the ramp gradient must not be such as to cause damage to the machine as it goes up.

6. Grip the handle (5) on the left-hand side of the recovery tank (**Fig.5**) and turn the tank as far as it will go.
7. Disconnect the electrical connector from the general system.

 **WARNING:** This process must be carried out by qualified personnel.

8. Grip the handle (5) and turn the recovery tank until it reaches the working position.
9. Go to the rear left area of the machine and engage the parking brake, turn the lever (3) anticlockwise (**Fig.6**). Secure the machine to the means of transport.

 **WARNING:** secure the device according to the directives in force in the country of use, so that it cannot slide or tip over.

MACHINE SAFETY

To ensure that work is carried out in the best safety conditions, proceed as follows:

1. Make sure the solution tank is empty. If this is not the case, empty it (read "[EMPTYING THE SOLUTION TANK](#)").
2. Make sure the recovery tank is empty. If this is not the case, empty it (read "[EMPTYING THE RECOVERY TANK](#)").
3. Check that the machine is off; if this is not the case, set the main switch (4) to position "0" by turning the key a quarter turn anti-clockwise (**Fig.4**). As soon as the machine is off, remove the key from the control panel.
4. Raise the brush head body and press the brush head control pedal (1) (on the rear of the machine) downwards (**Fig.1**).
5. Raise the squeegee body and move the squeegee control lever (2) upwards (**Fig.2**). The lever is located on the back of the machine.
6. Go to the rear left-hand side of the machine and engage the parking brake, turn the lever (3) anti-clockwise (**Fig.6**). Grip the handle (5) located on the right side of the recovery tank (**Fig.5**) and turn the recovery tank as far as it will go.
7. Disconnect the electrical connector from the general system.

 **WARNING:** This process must be carried out by qualified personnel.

8. Grip the handle (5) and turn the recovery tank until it reaches the working position.

TYPE OF BATTERY TO BE USED

Power to the machine must be supplied by four sealed traction batteries with gas recombination or gel technology. The batteries must meet the requirements laid out in the norms: CEI EN 60254-1:2005-12 (CEI 21-5) + CEI EN 60254-2:2008-06 (CEI 21-7). For a good operating performance, we suggest the use of two 12V MFP 77 Ah/C5 batteries. The machine must be powered with a voltage of 24V.

INSERTING THE BATTERIES IN THE MACHINE

To fit the batteries inside the machine, contact an COMAC assistance centre technician.

 **WARNING:** COMAC declines all responsibility for any damage to property or injury persons in the event that the batteries are replaced by an unauthorized technician.

BATTERY MAINTENANCE AND DISPOSAL

For battery maintenance and recharging, respect the instructions provided by the battery manufacturer.

When the batteries reach the end of their service life, they must be disconnected by a COMAC assistance centre technician or by a specialised and properly trained worker, and must be subsequently removed from the battery compartment using suitable lifting devices.





N.B.: dead batteries are classified as dangerous waste and as such must be delivered to an authorised body for disposal.

RECHARGING THE BATTERIES

The batteries must be charged prior to first use, and whenever they no longer provide sufficient power to perform the desired work.

 **CAUTION:** The control board and the battery charger, if present on board, can be set for gel batteries or for lead-acid batteries; contact the nearest COMAC assistance centre to modify the setting of the machine.

 **CAUTION:** to avoid any permanent damage to the batteries, it is essential to avoid their complete discharge; begin recharging them within a few minutes of noting the "discharged batteries" signal.

 **CAUTION:** Never leave the batteries completely discharged, even if the machine is not being used.

1. Bring the machine to the battery recharging area.

 **CAUTION:** park the machine in an enclosed place, on a flat and level surface; near the machine there must be no objects that could either damage it, or be damaged through contact with it.

 **DANGER:** the room used to recharge the batteries must be adequately ventilated to prevent the accumulation of gases that leak from batteries.

2. Perform the procedure for securing the machine (see the section titled "[SECURING THE MACHINE](#)").
3. Grip the handle (5) on the right-hand side of the recovery tank (**Fig.5**) and turn the tank as far as it will go.

To recharge the batteries without the built-in battery charger, proceed as follows:

 **CAUTION:** the following operations must be carried out by qualified personnel. An incorrect connection of the connector may cause a malfunction of the device.

- Disconnect the electric system connector from the battery connector.

- Connect the external battery charger cable to the battery connector.

 **N.B.:** the coupling connector of the battery charger is consigned inside the bag containing this instruction booklet, and must be assembled on the cables of the battery charger as indicated in the instructions.



DANGER: before connecting the batteries to the battery charger, make sure it is suitable for the batteries used.



N.B.: carefully read the use and maintenance instructions of the battery charger that is used for charging.



CAUTION: keep the recovery tank open for the duration of the battery recharging cycle to allow gas fumes to escape.

- Once the recharge cycle has been completed, rotate the recovery tank to the maintenance position and disconnect the battery charger's cable from the battery connector.
- Connect the electrical system connector to the battery connector.
- Grip the handle (5) and turn the recovery tank to its working position.

To recharge the batteries with the on-board battery charger proceed as follows:



CAUTION: the following operations must be carried out by qualified personnel. An incorrect connection of the connector may cause a malfunction of the device.



N.B.: Carefully read the use and maintenance instructions of the battery charger that is used for charging, this document is delivered along with the machine.



CAUTION: before connecting the batteries to the battery charger, make sure it is suitable for the batteries used.



N.B.: the battery charger power cable is delivered inside the bag containing this instruction booklet.

- Plug the battery charger cable into the mains socket.
- Connect the battery charger's power cable to the socket on the battery charger itself.
- Grip the handle (5) on the left-hand side of the recovery tank (**Fig.5**) and turn the tank as far as it will go.



CAUTION: keep the recovery tank open for the duration of the battery recharging cycle to allow gas fumes to escape.

- Once the recharge cycle has been completed, rotate the recovery tank to the maintenance position and disconnect the battery charger's cable from the battery connector.
- Connect the electrical system connector to the battery connector.
- Grip the handle (5) and turn the recovery tank to its working position.

INSERTING WATER SYSTEM FILTER

Before using the machine for the first time the water system filter needs to be reset, for shipping reasons the filter cartridge and the cap have been removed. To insert the filter cartridge in the water system filter body proceed as follows:

1. Take the machine to the maintenance area.
2. Make sure the machine has been secured (see the section titled "[SECURING THE MACHINE](#)").



CAUTION: It is recommended to wear the appropriate PPE (Personal Protective Equipment), suitable for the work to be carried out.

3. Tighten the outlet flow of the tap, move the lever (6) on the rear part of the machine upwards (**Fig.7**).
4. Go to the left side of the machine, screw the filter cap (7) into the hole in the solution tank (**Fig.8**).



N.B.: Check that the o-ring seal in the filter cap is positioned correctly.

ASSEMBLING THE BRUSH

For packaging reasons, the brush is supplied disassembled from the machine. To assemble it on the brush head body, proceed as follows:

1. Perform the procedure for securing the machine (see the section titled "[SECURING THE MACHINE](#)").



CAUTION: It is recommended to wear the appropriate PPE (Personal Protective Equipment), suitable for the work to be carried out.

2. With the brush head in the raised position, insert the brush into the flange in the brush head body and rotate the brush until the three buttons (8) on the brush slot into the holes located on the brush holder plate (**Fig.9**).
3. To lock, click them into position by turning them anticlockwise to the direction of travel.

ASSEMBLING THE SQUEEGEE BODY

For packaging reasons, the squeegee body comes disassembled from the machine. In order to mount it on the squeegee support, do the following:

1. Make sure the machine is in a safe condition (read "[MACHINE SAFETY](#)").
2. Raise the squeegee body, moving the squeegee control lever (2) upwards in the direction of the arrow (**Fig.2**). The lever is located on the back of the machine.

 **CAUTION:** It is recommended to wear the appropriate PPE (Personal Protective Equipment), suitable for the work to be carried out.

3. Unscrew the knobs (9) in the squeegee body pre-assembly (**Fig.10**).
4. First insert the left pin (10) on the squeegee body into the left slit (11) in the squeegee support and tighten the knob (9), making sure that the washer (12) is positioned above the upper part of the squeegee support (**Fig. 11**).
5. Tighten the knobs (9) to fix the squeegee body to the support.
6. Repeat the same operation for the right pin.
7. Insert the vacuum tube (13) in the sleeve (14) in the squeegee body (**Fig.12**).

 **N.B.:** the tube must be positioned behind the squeegee lifting chain.

 **N.B.:** Although the squeegee comes pre-adjusted, it is nevertheless recommended to read the section entitled "ADJUSTING THE SQUEEGEE BODY RUBBER BLADES".

FILLING THE SOLUTION TANK WITH WATER

Before filling the solution tank, carry out the following steps:

1. Take the machine to the usual place for filling the solution tank.
2. Perform the procedure for securing the machine (see the section titled "[SECURING THE MACHINE](#)").
3. Check that the solution tank discharge cap (7) is open. If it isn't, open it (**Fig.7**).
4. Removing the filler opening cap (15) and filling the solution tank by means of a rubber hose or a bucket (**Fig.12**).
5. Fill with clean water, at a temperature not higher than 50°C and not lower than 10°C. You can check the quantity in the tank by means of the level tube (16) (**Fig. 13**).

 **N.B.:** Before filling the tank, check that the filter (17) is correctly positioned inside the filler opening (**Fig.12**).

DETERGENT SOLUTION

After filling the solution tank with clean water, add the liquid detergent to the tank in the concentration and manner indicated on the detergent manufacturer's label. To prevent the formation of an excessive amount of foam that could damage the vacuum motor, use the minimum percentage of detergent required.

 **CAUTION:** It is recommended to wear the appropriate PPE (Personal Protective Equipment), suitable for the work to be carried out.

 **ATTENTION:** always use detergents whose manufacturer's label indicates their suitability for scrubbing machines. Do not use acid or alkaline products or solvents without this indication.

 **ATTENTION:** always use low-foam detergent. To avoid the production of foam, put a minimum quantity of antifoam liquid in the recovery tank before starting to clean. Do not use pure acids.

 **N.B.:** to make it easier to measure the detergent on the cap/measuring device, there are two notches indicating the two main detergent percentage quantities that can be used.

PREPARING TO WORK

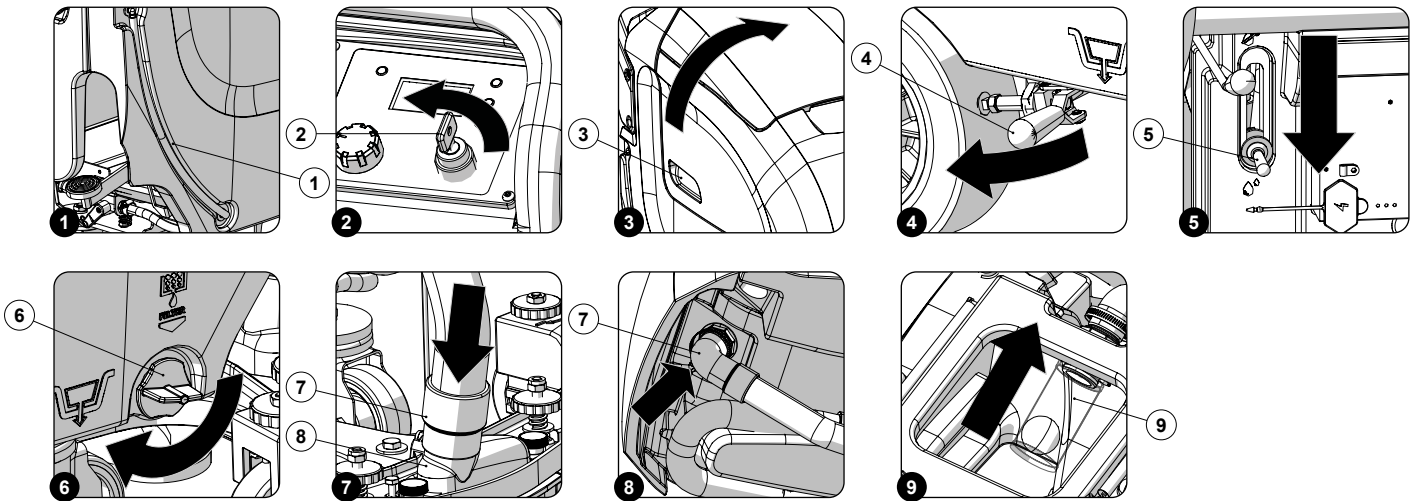

Before beginning to work, it is necessary to:

1. Make sure the recovery tank is empty. If this is not the case, empty it (read [“EMPTYING THE RECOVERY TANK”](#)).
2. Check that the amount of detergent solution in the solution tank is sufficient for the type of work to be performed. If it isn't, top up the solution tank (see [“FILLING THE SOLUTION TANK WITH WATER”](#) and [“DETERGENT SOLUTION”](#)). Check the level tube (1) in the rear right-hand part of the machine (**Fig.1**).
3. Check the rubber squeegee blades are in good working condition. If they aren't, replace them (see [“REPLACING THE SQUEEGEE BODY RUBBER BLADES”](#)).
4. Check the brush is in good working condition. If it isn't, replace it (see [“REPLACING THE BRUSH ”](#)).
5. Check that the machine is off; if this is not the case, set the main switch (2) to position "0" by turning the key a quarter turn anti-clockwise (**Fig.2**). As soon as the machine is off, remove the key from the control panel.
6. Grip the handle (3) on the right-hand side of the recovery tank (**Fig.3**) and turn the tank as far as it will go, until it reaches the maintenance position.
7. Connect the main system connector to the battery connector.

⚠ ATTENTION: This process must be carried out by qualified personnel.

8. Grip the handle (3) and turn the recovery tank until it reaches the working position.
9. Check that the parking brake (4) is not engaged; if it is, turn the lever anti-clockwise (**Fig.4**).
10. Check that the detergent solution tap is fully open, move the tap control lever (5) downwards (**Fig.5**).
11. Check that the solution tank filter-cap (6) is closed. If this is not the case, close it (**Fig.6**).
12. Make sure the cap of the recovery tank drainage tube is closed. If it isn't, close it.
13. Make sure the vacuum tube (7) is correctly connected to the sleeve (8) in the squeegee body. If it isn't, connect it (**Fig.7**).
14. Make sure the vacuum tube (7) is correctly inserted into the tube holder in the recovery tank. If this is not the case, connect it (**Fig.8**).
15. Make sure the overfill level float (9) is working correctly (**Fig.9**). If it isn't, clean it (see [“CLEANING THE SUCTION MOTOR FILTER”](#)).

STARTING WORK

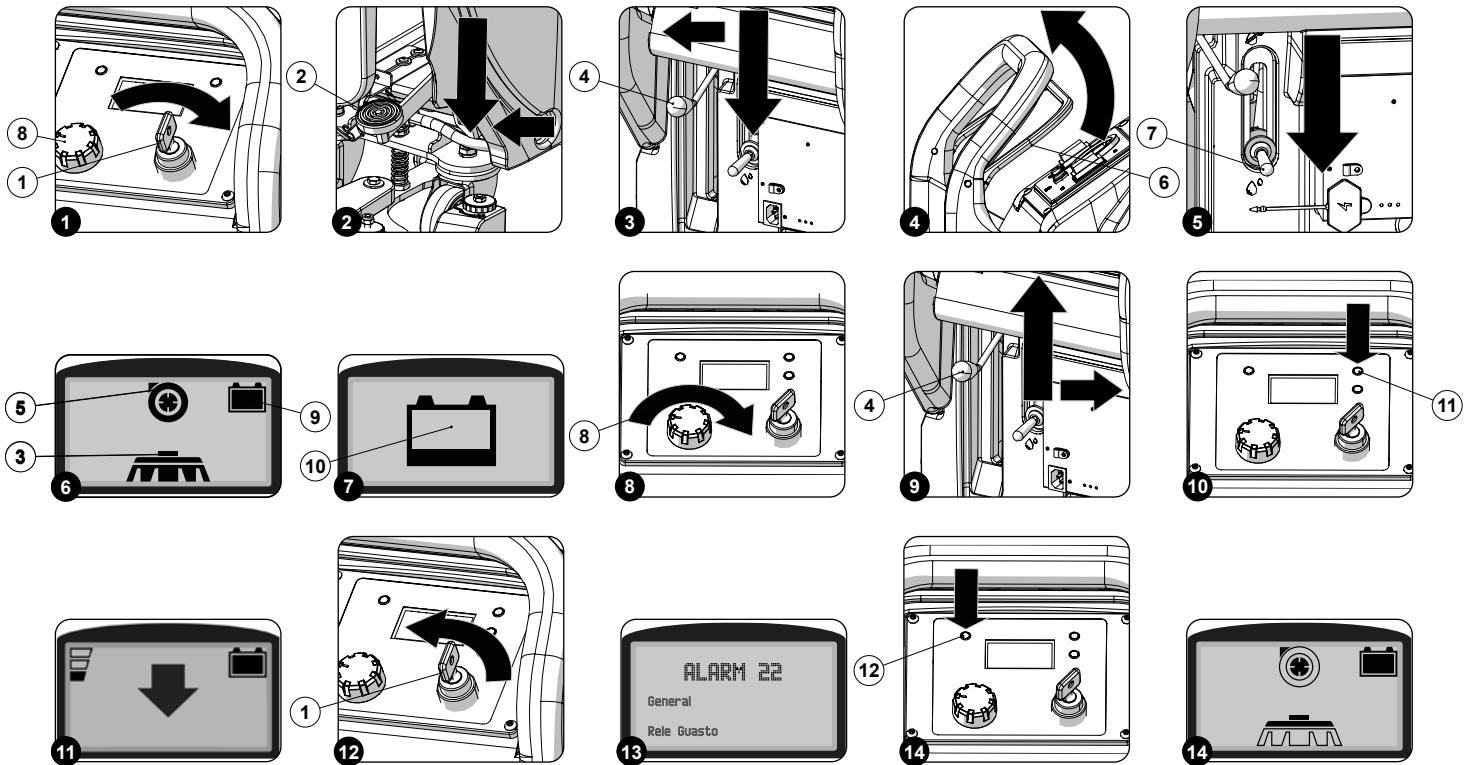

The machine can be used in the following work modes:

- ECO-MODE, read the section "[ECO-MODE](#)".
- STANDARD MODE.

As an example, we will look at the Standard mode. To begin working in this mode, proceed as follows:

1. Carry out all the checks listed in the section "PREPARING TO WORK".
2. Go to the driving position, behind the machine.
3. Insert the key (1) into the main switch on the control panel. Set the main switch to "I" (Fig.1).

i **N.B.:** If the dead man's lever is activated during start-up, the ALARM 14 will appear on the display and none of the machine controls will function; the dead man's lever must first be released.

4. When the display comes on, three screens appear in sequence.
 - The first screen displayed indicates the name of the machine.
 - The second screen shows the machine programming characteristics.
 - The third screen displays the work panel.

i **N.B.:** the steps for a complete scrubbing and drying cycle are explained below.

5. Lower the brush head body and detach the pedal (2) at the rear of the machine from the plate retainer (Fig.2).

i **N.B.:** As soon as the brush head body is in the working position, the symbol (3) will appear on the control display (Fig.6).

6. Lower the squeegee body and detach the lever (3) at the rear of the machine from the plate retainer (Fig.3).

i **N.B.:** As soon as the squeegee body is in the working position, the symbol (5) will appear on the control display (Fig.6).

i **N.B.:** Once the squeegee body has reached its working position, the suction motor will enter into function.



7. By pressing the dead man's lever (6) (Fig.4), the solenoid valve will begin to deliver the detergent solution to the brush, and the gear motor present in the brush head body and the traction gear motor will be powered and will begin to work.

i **N.B.:** Once the brush head body has reached its working position, the corresponding gearmotor start working.

i **N.B.:** If the speed adjustment knob (5) (Fig.1) is turned fully to the minimum setting, the machine will not move.

8. During the first few metres, check whether the detergent solution being delivered is appropriate to the work to be carried out; if this is not the case, adjust it by moving the lever (6) on the rear part of the machine (**Fig.5**) (see "[ADJUSTING THE FLOW OF DETERGENT SOLUTION](#)").

The machine will now begin to work with full efficiency until the battery is flat or until the detergent solution has finished. During the first few metres, check that there is sufficient solution and that the squeegee is drying correctly.



-  **N.B.:** If the dead man's lever is released during the work, the brush motor, the suction motor and the traction motor will stop, with the corresponding delays.
-  **N.B.:** If the dead man's lever is released during the work, the solenoid valve will cease to deliver the detergent solution.
-  **N.B.:** when filling the solution tank, it is good practice to empty the recovery tank using the special drainage hose.

HOURLY METER

The machine control panel contains the control display, which shows the total usage time. The numbers before the letter "h" identify the hours, while the numbers before the letter "m" identify the tenths of an hour (a tenth of an hour corresponds to six minutes). The flashing ":" symbol indicates that the hour meter is counting the machine functioning time.







BATTERY CHARGE LEVEL INDICATOR

The device instrument panel contains the control display. At the top right of the work screen, there is a graphic symbol (9) representing the battery charge level indicator (**Fig.6**). The indicator is composed of 5 charge levels, each of which represents about 20% of residual charge. With a residual charge of 20%, the graphic symbol starts to flash. After a few seconds it appears in larger dimensions in the middle of the screen (**Fig.7**); at this point, you must take the machine to the designated recharging place.

-  **N.B.:** a few seconds after the battery charge level reaches 20%, the brush motor switches off automatically. With the remaining charge it is still possible, however, to complete the drying process before recharging
-  **N.B.:** a few seconds after the battery charge level reaches 10%, the suction motor switches off automatically. The remaining charge is sufficient for moving the appliance to the designated recharging place

SCRUBBING WITH DRYING





To carry out "SCRUBBING AND DRYING" tasks, proceed as follows:

1. Go to the driving position, behind the machine.
 2. Insert the key (1) into the main switch on the control panel. Set the main switch to "I" (**Fig.1**).
 3. Lower the brush head body and detach the pedal (2) at the rear of the machine from the plate retainer (**Fig.2**).
 4. Lower the squeegee body and detach the lever (4) at the rear of the machine from the plate retainer (**Fig.3**).
-  **N.B.:** Once the squeegee body has reached its working position, the suction motor will enter into function.
5. By pressing the dead man's lever (4) (**Fig.4**), the solenoid valve will begin to deliver the detergent solution to the brush, and the gear motor present in the brush head body and the traction gear motor will be powered and will begin to work.
-  **N.B.:** Once the brush head body has reached its working position, the corresponding gearmotor start working.
 -  **N.B.:** If the speed adjustment knob (5) (**Fig.1**) is turned fully to the minimum setting, the machine will not move.
6. During the first few metres, check whether the detergent solution being delivered is appropriate to the work to be carried out; if this is not the case, adjust it by moving the lever (6) on the rear part of the machine (**Fig.5**) (see "[ADJUSTING THE FLOW OF DETERGENT SOLUTION](#)").
-  **N.B.:** If the dead man's lever is released during the work, the brush motor, the suction motor and the traction motor will stop, with the corresponding delays.
 -  **N.B.:** If the dead man's lever is released during the work, the solenoid valve will cease to deliver the detergent solution.
 -  **N.B.:** when filling the solution tank, it is good practice to empty the recovery tank using the special drainage hose.

SCRUBBING WITHOUT DRYING

To carry out "SCRUBBING WITHOUT DRYING" tasks, proceed as follows:

1. Go to the driving position, behind the machine.
2. Insert the key (1) into the main switch on the control panel. Set the main switch to "I" (**Fig.1**).
3. Lower the brush head body and detach the pedal (2) at the rear of the machine from the plate retainer (**Fig.2**).
4. By pressing the dead man's lever (4) (**Fig.4**), the solenoid valve will begin to deliver the detergent solution to the brush, and the gear motor present in the brush head body and the traction gear motor will be powered and will begin to work.



-  **N.B.:** Once the brush head body has reached its working position, the corresponding gearmotor start working.
-  **N.B.:** If the speed adjustment knob (5) (**Fig.1**) is turned fully to the minimum setting, the machine will not move.
- 5. During the first few metres, check whether the detergent solution being delivered is appropriate to the work to be carried out; if this is not the case, adjust it by moving the lever (6) on the rear part of the machine (**Fig.5**) (see "[ADJUSTING THE FLOW OF DETERGENT SOLUTION](#)").
-  **N.B.:** If the dead man's lever is released during the work, the brush motor and the traction motor will stop, with the corresponding delays.
-  **N.B.:** If the dead man's lever is released during the work, the solenoid valve will cease to deliver the detergent solution.

SCRUBBING WITH DRYING

To carry out "DRYING" tasks, proceed as follows:



The drying without scrubbing operation should only be carried out if the machine was previously used to carry out a scrubbing without drying operation.

1. Go to the driving position, behind the machine.
2. Insert the key (1) into the main switch on the control panel. Set the main switch to "I" (**Fig.1**).
3. Lower the squeegee body and detach the lever (3) at the rear of the machine from the plate retainer (**Fig.3**).
-  **N.B.:** As soon as the squeegee body is in the working position, the symbol (5) will appear on the control display (**Fig.6**).
-  **N.B.:** Once the squeegee body has reached its working position, the suction motor will enter into function.
4. By pressing the dead man's lever (4) (**Fig.4**), the solenoid valve will begin to deliver the detergent solution to the brush, and the gear motor present in the brush head body and the traction gear motor will be powered and will begin to work.
-  **N.B.:** If the speed adjustment knob (5) (**Fig.1**) is turned fully to the minimum setting, the machine will not move.
5. Drying.

ADJUSTMENT OF THE DETERGENT SOLUTION FLOW



To adjust the flow of detergent solution on the brush, proceed as follows:

1. Open the detergent solution outlet flow to the maximum, move the tap control lever (7) downwards (**Fig.5**).
2. When the dead man's lever is pressed (6) (**Fig.4**), the solenoid valve will distribute the detergent solution to the brush.
3. During the first few metres of work, check that the amount of solution is sufficient to wet the floor; if necessary, use the lever (7) to adjust the amount being delivered.

REGULATING THE FORWARD SPEED



This machine is equipped with electronic traction control. To regulate the potentiometer, proceed as follows:

During the work, adjust the forward speed by gradually turning the knob (8) (**Fig.8**) clockwise.

-  **N.B.:** the device will not start to move (either forward or backward) if the potentiometer adjustment knob (8) is set to minimum.
-  **N.B.:** Forward speed can be increased by turning the potentiometer's knob (8) clockwise.

REVERSE GEAR

To reverse, proceed as follows:

1. Lift the squeegee body by moving the lever (4) at the rear of the machine upwards (**Fig.9**).
-  **N.B.:** to lock the squeegee in the raised position, move the lever (4) as far as it will go and then move it towards the right-hand side of the machine (**Fig.9**).
2. Press the "REVERSE MOVEMENT ACTIVATION - DEACTIVATION" button(11) on the control panel (**Fig.10**).
3. On pressing the dead man's lever (6) (**Fig.4**), the machine will begin to move in reverse.
-  **N.B.:** As soon as the button (11) on the control panel is pressed, the control display will show the "REVERSE" screen (**Fig.11**).

i **N.B.:** the reverse speed is lower than the forward speed to comply with current health and safety standards. If the potentiometer is adjusted while reversing, the adjustment of the forward speed will be automatically changed.

⚠ **ATTENTION:** it is impossible to reverse if the squeegee unit touches the floor. In order to reverse, lift the squeegee unit from the floor using the relevant lever on the back of the appliance.

i **N.B.:** To disable reverse movement, press the button (11) on the control panel again.

ALARM SCREEN

If an error occurs, the control display will show the screen for the error, and it will remain visible until the error is resolved.

When an error occurs, do as follows:

1. Stop the machine.
2. Switch off the machine, turning the main switch (1) to position "0"; turn the key a quarter turn anti-clockwise (**Fig.12**). As soon as the machine is off, remove the key from the control panel.
3. Contact the nearest service centre to explain the issue the machine is having referring the code (3) and the alarm designation (4) will be shown on the display (**Fig.13**).

ECO MODE

This machine has a working function which reduces the energy absorption. To activate or deactivate the eco-mode function just press the button (12) on the instrument panel (**Fig.14**).

When the eco-mode function is active, the symbols for the working programs will change and only the contours will remain visible, like the example in **Fig.15**, where the scrubbing with drying in eco-mode symbol is shown.

OVERFLOW DEVICE

The machine is NOT equipped with an overflow device, because the volume of the recovery tank is greater than the capacity of the solution tank. In extraordinary cases, there is a mechanical device (float) under the recovery tank lid that, when the recovery tank is full, shuts off the air to the vacuum motor intake to protect it; the sound of the suction motor will then be deeper. Empty the recovery tank (see "[EMPTYING THE RECOVERY TANK](#)").

AT THE END OF THE WORK

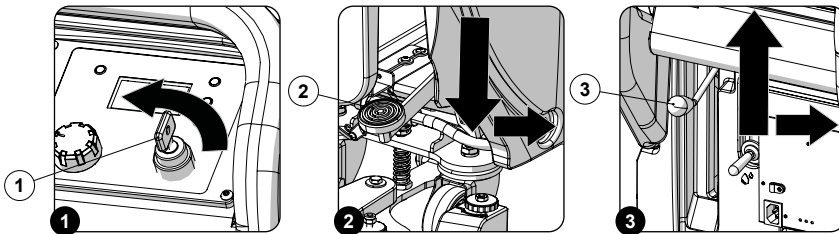

At the end of the work, and before carrying out any type of maintenance, perform the following operations:

1. Switch off the machine, turning the main switch (1) to position "0"; turn the key a quarter turn anti-clockwise (**Fig.1**). As soon as the machine is off, remove the key from the control panel.
2. Raise the brush head body and press the brush head control pedal (2) (on the rear of the machine) downwards (**Fig.2**).
3. Raise the squeegee body and move the squeegee control lever (3) upwards (**Fig.3**). The lever is located on the back of the machine.
4. Take the machine to the maintenance area.
5. Carry out all the procedures listed in the chapter "[RECOMMENDED PERIODIC MAINTENANCE](#)" indicated in the column "AT THE END OF THE WORK".
6. Once the maintenance operations are complete, take the machine to the designated storage location.

⚠ **ATTENTION:** Park the machine in an enclosed place, on a flat surface; near the machine there must be no objects that could either damage it, or be damaged through contact with it.

7. Secure the machine, see the section titled "[SECURING THE MACHINE](#)".

RECOMMENDED MAINTENANCE OPERATIONS

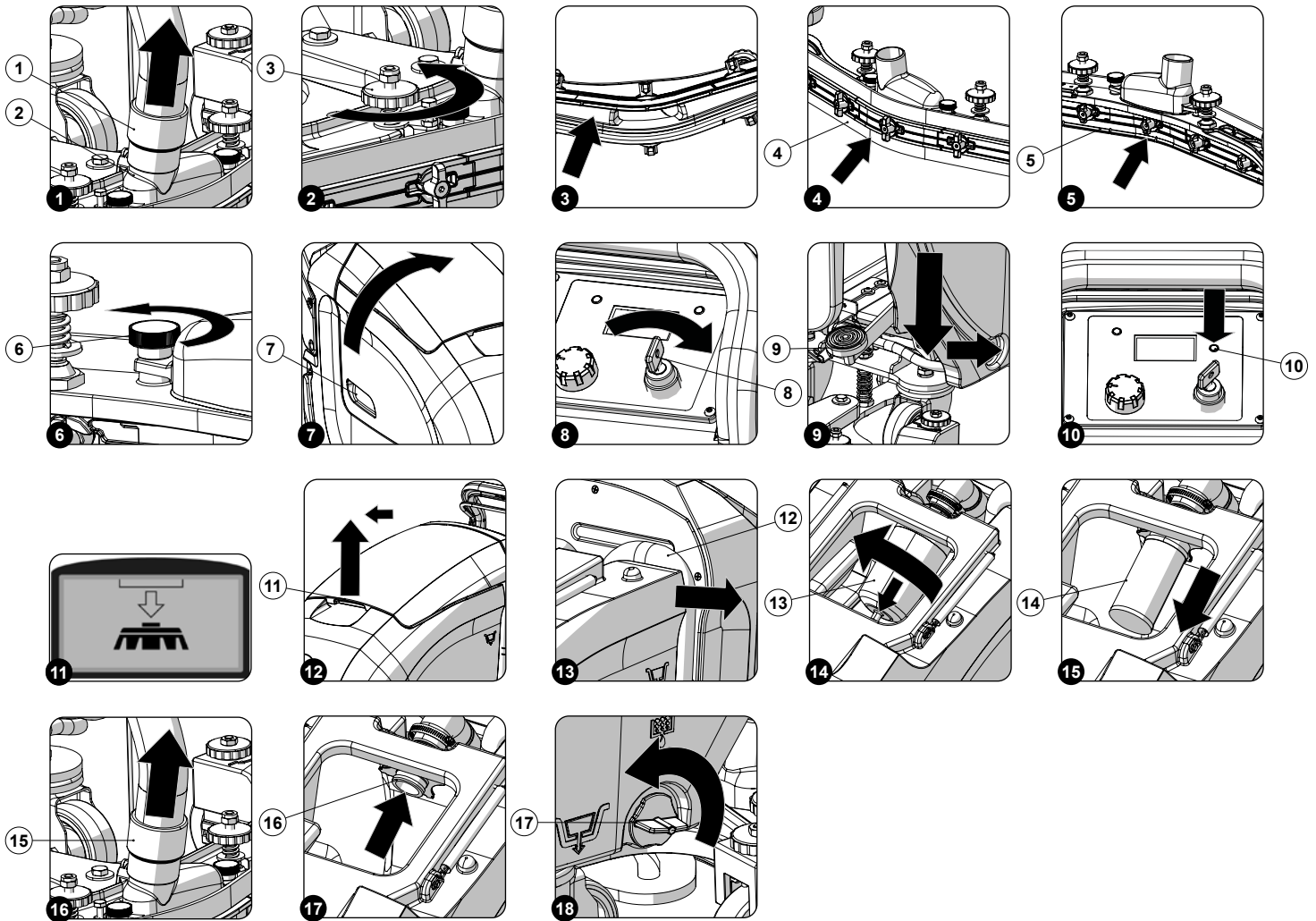

INTERVAL	MACHINE COMPONENTS	PROCEDURE
DAILY BEFORE A LONG PERIOD OF INACTIVITY	Squeegee	Clean the vacuum chamber; the squeegee rubber blades; the vacuum nozzle (see " CLEANING THE SQUEEGEE BODY ").
	Brush head brushes	Clean the brush located in the brush head body (see " CLEANING THE BRUSH HEAD BRUSH ").
	Recovery tank	At the end of every working day, empty the recovery tank (see " EMPTYING THE RECOVERY TANK ").
		At the end of every working day, after having emptied the recovery tank, clean the vacuum system filter (see " CLEANING THE SUCTION MOTOR FILTER ").
	Solution tank	At the end of every working day, after having emptied the recovery tank, clean the vacuum tube (see " CLEANING THE VACUUM TUBE ").
WEEKLY	Machine water system	Clean the filter in the machine's water system (see " CLEANING THE WATER SYSTEM FILTER ").
	Squeegee rubber blades	Check that the rubber blades on the squeegee body are intact and inspect for wear; if necessary, replace these (see " REPLACING THE SQUEEGEE BODY RUBBER BLADES ").
	Brush head brushes	Check that the brush in the brush head body is intact and inspect for wear; if necessary, replace this (see " REPLACING THE BRUSH HEAD BRUSH ").
MONTHLY	Squeegee rubber blade levelling	Check that the rubber blades on the squeegee body are level and if necessary, adjust these (see " ADJUSTING THE SQUEEGEE BODY RUBBER BLADES ").

Before carrying out any routine maintenance operations, proceed as follows:

1. Take the machine to the maintenance area.



N.B.: the place designated for this operation must comply with current environmental protection regulations.

2. Make sure the machine is in a safe condition (see chapter "[MACHINE SAFETY MEASURES](#)").



CAUTION: it is recommended to wear the appropriate PPE (Personal Protective Equipment), suitable for the work to be carried out.

CLEANING THE SQUEEGEE BODY

The careful cleaning of the whole vacuum unit ensures better drying and cleaning of the floor as well as a longer suction motor life. To carry out the cleaning of the squeegee body, proceed as follows:

1. Remove the vacuum hose (1) from the vacuum nozzle (2) on the squeegee unit (**Fig.1**).
2. Completely unscrew the knobs (3) on the squeegee body pre-assembly (**Fig.2**).
3. Remove the squeegee body from the slits in the squeegee connector.
4. Thoroughly clean the squeegee body vacuum chamber with a jet of water, and then with a damp cloth (**Fig.3**).
5. Thoroughly clean the squeegee body's rear rubber blade (4) with a jet of water, and then with a damp cloth (**Fig.4**).
6. Thoroughly clean the squeegee body front rubber blade (5) with a jet of water, and then with a damp cloth (**Fig.5**).
7. Fully unscrew the knobs (6) that fix the nozzle to the squeegee body (**Fig.6**).
8. Thoroughly clean the vacuum nozzle with a jet of water, and then with a damp cloth.
9. Proceed in the opposite order to reassemble all the parts.



N.B.: Check the wear of the rear rubber blade (4) and the front rubber blade (5) on the squeegee body; if the edge of the rubber in contact with the floor is worn, replace it. See "[REPLACING THE SQUEEGEE BODY RUBBER BLADES](#)".

CLEANING THE BRUSH HEAD BRUSH

Careful cleaning of the brush guarantees better cleaning of the floor, as well as a longer brush head gearmotor lifespan. To clean the brush, proceed as follows:

1. Grip the handle (7) on the right-hand side of the recovery tank (**Fig.7**) and turn the tank as far as it will go.
2. Connect the electrical system connector to the battery connector.
3. Grip the handle (7) and turn the recovery tank to its working position.
4. Go to the front of the machine.
5. Insert the key (8) into the main switch on the control panel. Set the main switch to "I" (**Fig.8**).
6. Raise the brush head body and press the brush head control pedal (9) (on the rear of the machine) downwards (**Fig.9**).
7. With the brush head in the raised position, press the brush uncoupling button (10) present on the control panel.



N.B.: As soon as the button (10) on the display has been pressed, the symbol that indicates that the brush uncoupling function is active will appear (**Fig.11**).

8. Press the button (10) again to activate the brush uncoupling function.



CAUTION: do not stand near the brush head body while the brush is being uncoupled.

9. Clean the brush under running water to remove any impurities from its bristles.
10. See "[INSTALLING THE BRUSH](#)" for instructions on refitting the brushes in the brush head body.



N.B.: Check that the bristles are not worn; in the event of excessive wear, replace the brush (the bristles should be at least 10 mm long). Read the paragraph "[REPLACING THE BRUSH](#)" to replace the brush.

DRAINING THE RECOVERY TANK

Proceed as follows to empty the recovery tank:

1. Grip the handle (11) and move the recovery tank cover to the side (**Fig.12**).
2. Remove the recovery tank drainage tube (12) from the stops; it is located in the space between the recovery tank and the solution tank (**Fig.13**).
3. Bend the end of the drainage tube, so as to create a choke and prevent the contents from coming out, put the tube on the discharge surface, unscrew the cap and gradually release the tube.
4. Repeat the operations in reverse order to reassemble all the parts.

CLEANING THE SUCTION MOTOR FILTER

Careful cleaning of the suction motor filter guarantees better cleaning of the floor as well as a longer life for the suction motor. Clean the suction motor filter as follows:

1. Make sure the recovery tank is empty. If this is not the case, empty it (read "[EMPTYING THE RECOVERY TANK](#)").
2. Grip the handle (11) and move the recovery tank cover to the side (**Fig.12**).
3. Remove the float cover (13), turning it in the direction of the arrow (**Fig.14**).
4. Remove the filter-float (14) (**Fig.15**). Rinse the inside with a jet of water. If necessary, use a spatula to remove the sludge that has accumulated at the bottom of the float.
5. Repeat the operations in reverse order to reassemble all the parts.

CLEANING THE VACUUM TUBE

Careful cleaning of the vacuum hose guarantees better cleaning of the floor as well as a longer suction motor life. Proceed as follows to clean the vacuum hose:

1. Stand at the back of the machine.
2. Extract the vacuum tube (15) from the vacuum nozzle on the squeegee body (**Fig.16**).
3. Grip the handle (11) and move the recovery tank cover to the side (**Fig.12**).
4. Remove the float cover (13), turning it in the direction of the arrow (**Fig.14**).
5. Remove the filter-float (14) (**Fig.15**).
6. Insert the water pipe into the filter-float support (16) and clean the inside of the suction pipe with a jet of running water (**Fig.17**).
7. Repeat the operations in reverse order to reassemble all the parts.

EMPTYING THE SOLUTION TANK

Proceed as follows to empty the solution tank:

1. Remove the detergent solution cap-filter (17), turning it anti-clockwise (**Fig.18**).
2. Remove the cap and empty the tank. With the solution tank empty, rinse the inside of the solution tank with a jet of running water.
3. Repeat the operations in reverse order to reassemble all the parts.

CLEANING THE WATER SYSTEM FILTER

Careful cleaning of the water system filter guarantees better cleaning of the floor as well as a longer lifespan of the solenoid valve present in the brush head body. To clean the water system filter, proceed as follows:

1. Remove the detergent solution cap-filter (17), turning it anti-clockwise (**Fig.18**).
2. Remove the filter-cap and rinse under a jet of water, using a brush to eliminate any impurities if necessary.
3. When the filter-cap is clean, repeat the operations in the reverse order to reassemble all the parts.

EXTRAORDINARY MAINTENANCE WORK

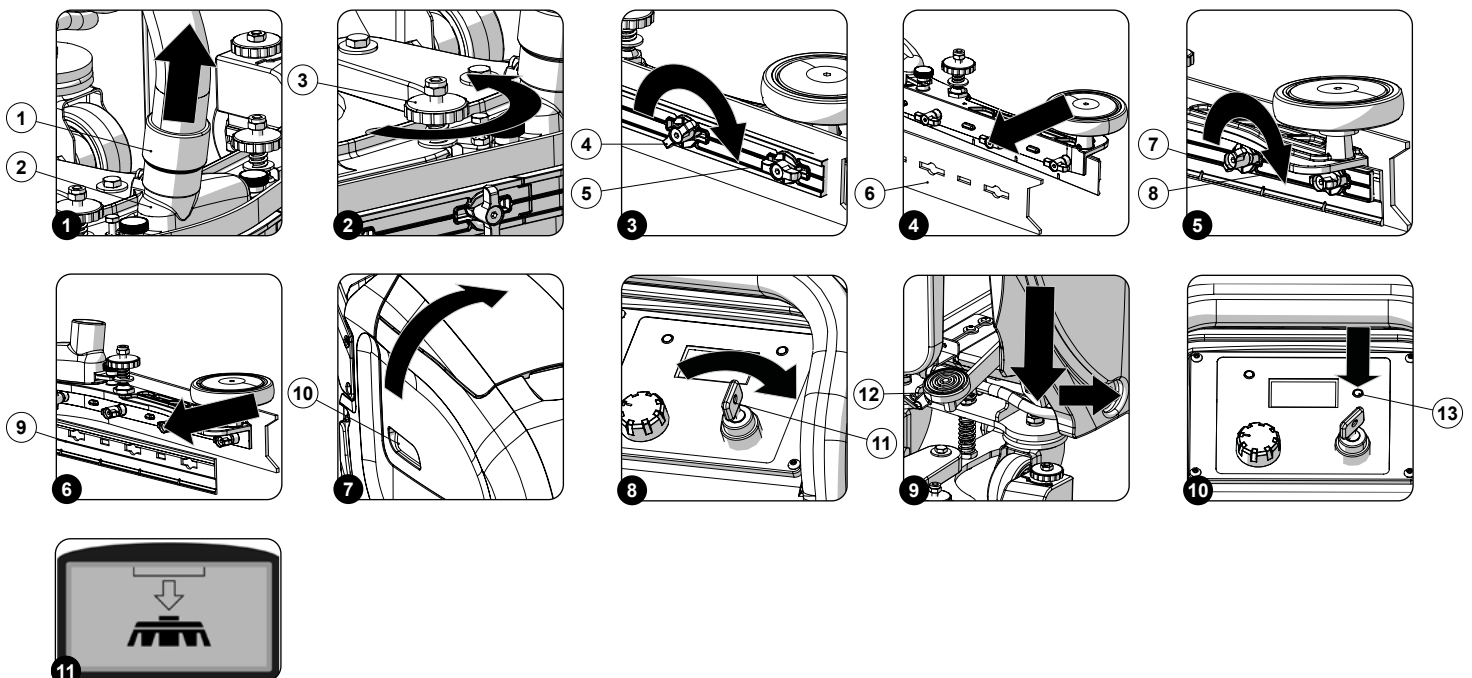

Before carrying out any routine maintenance operations, proceed as follows:

1. Take the machine to the maintenance area.



N.B.: the place designated for this operation must comply with current environmental protection regulations.

2. Make sure the machine is in a safe condition (see chapter "[MACHINE SAFETY MEASURES](#)").



CAUTION: it is recommended to wear the appropriate PPE (Personal Protective Equipment), suitable for the work to be carried out.

REPLACING THE SQUEEGEE BODY RUBBER BLADES

Ensuring the integrity of the squeegee body's rubber blades guarantees better floor cleaning and drying results, as well as a longer service life for the suction motor. In order to replace the squeegee body's rubber blades, do the following:

1. Remove the vacuum hose (1) from the vacuum nozzle (2) on the squeegee unit (**Fig.1**).
2. Completely unscrew the knobs (3) on the squeegee body pre-assembly (**Fig.2**).
3. Remove the squeegee body from the slits in the squeegee connector.

To remove the rear squeegee rubber blade, proceed as follows:

- Turn the knobs (4) to a horizontal position and remove the rear rubber blade presser (5) (**Fig.3**).
- Remove the rear rubber blade (6) from the squeegee body (**Fig.4**).
- Replace the worn rubber blade with a new one.



N.B.: The rubber blade can be rotated symmetrically to be used more than once.

- Repeat the operations in reverse order to reassemble all the parts.

To remove the front squeegee rubber blade, proceed as follows:

- Turn the knobs (7) to a horizontal position and remove the front rubber blade presser (8) (**Fig.5**).
- Remove the rear rubber blade (9) from the squeegee body (**Fig.6**).
- Replace the worn rubber blade with a new one.
- Repeat the operations in reverse order to reassemble all the parts.



N.B.: Before using the machine, remember to adjust the squeegee body: see the section titled "[ADJUSTING THE SQUEEGEE BODY'S RUBBER BLADES](#)".



N.B.: It is recommended to replace both squeegee body blades in order to ensure good results when drying the floor.

REPLACING THE BRUSH

The good condition of the brush guarantees better cleaning of the floor, as well as a longer brush head gearmotor lifespan. To replace the brush, proceed as follows:

1. Grip the handle (10) on the right-hand side of the recovery tank (**Fig.7**) and turn the tank as far as it will go.
2. Connect the electrical system connector to the battery connector.
3. Grip the handle (10) and turn the recovery tank to its working position.
4. Go to the front of the machine.
5. Insert the key (11) into the main switch on the control panel. Set the main switch to "I" (**Fig.8**).
6. Raise the brush head body and press the brush head control pedal (12) (on the rear of the machine) downwards (**Fig.9**).
7. With the brush head in the raised position, press the brush uncoupling button (13) present on the control panel.



N.B.: As soon as the button (13) on the display has been pressed, the symbol that indicates that the brush uncoupling function is active will appear (**Fig.11**).

8. Press the button (13) again to activate the brush uncoupling function.



CAUTION: do not stand near the brush head body while the brush is being uncoupled.

9. See "[INSTALLING THE BRUSH](#)" for instructions on refitting the brushes in the brush head body.

ADJUSTMENT INTERVENTIONS

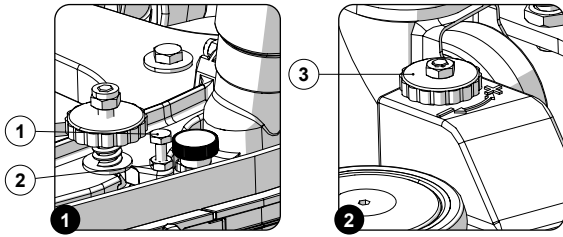

Before carrying out any adjustments, proceed as follows:

1. Take the machine to the maintenance area.



N.B.: the place designated for this operation must comply with current environmental protection regulations.

2. Make sure the machine is in a safe condition (see chapter "[MACHINE SAFETY MEASURES](#)").

⚠ CAUTION: it is recommended to wear the appropriate PPE (Personal Protective Equipment), suitable for the work to be carried out.

ADJUSTING THE SQUEEGEE BODY'S RUBBER BLADES

The careful adjustment of the squeegee body rubber blades guarantees better cleaning of the floor.

Adjusting the tilt of the squeegee body:

1. The angle of incline of the squeegee body is adjusted by means of the screw (1) located on the squeegee support (**Fig.1**).
2. To adjust the inclination of the squeegee body, loosen the nut (2) and tighten or loosen the screw (1) (**Fig.1**), until the squeegee body rubber blades are bent towards the outside evenly along the entire length by about 30° with respect to the floor.



N.B.: Turning the screw (1) clockwise increases the inclination of the central part of the squeegee body.

3. Once the adjustment has been completed, tighten the nut (2).

Adjusting the height of the squeegee body:

1. The distance of the squeegee rubber blades from the floor can be adjusted by changing the distance between the wheels located on the squeegee support and the floor itself.
2. To adjust the height of the wheels, simply use the knobs (3) located on the squeegee support (**Fig.3**).



N.B.: To decrease the distance between the wheels and the floor, simply turn the adjustment levers (3) in the direction indicated by the arrows with the sign "-", while to increase the distance just follow the arrows with the "+" sign.



N.B.: By decreasing the distance between the squeegee support and the floor, the rubber blades present in the squeegee's body move closer to the floor.



N.B.: For effective drying, the wheels must be at the same distance from the floor.



N.B.: Check for proper adjustment by looking at the instrument (3) positioned on the squeegee body (**Fig.3**).

BRUSHES AND BRUSH PAD HOLDER

MODEL	CODE	QTY	BRISTLE	NOTES
Agila 40/43 Bt	452403	1	PPL 0,4	DISC BRUSH øDf=410mm øDe=430mm (COLOUR: BLUE)
	452404	1	PPL 0.6	DISC BRUSH øDf=410mm øDe=430mm (COLOUR: WHITE)
	452405	1	PPL 0,8	DISC BRUSH øDf=410mm øDe=430mm (COLOUR: BLACK)
	452406	1	TYNEX	DISC BRUSH øDf=410mm øDe=430mm
	452407		TAMPICO	
	452414	1	-	BRUSH PAD HOLDER øDf=410mm WITH CENTER LOCK
Agila 40/50 Bt Agila 50/50 Bt	404654	1	PPL 0.3	DISC BRUSH øDf=485mm øDe=508mm (COLOUR: BLUE)
	405631	1	PPL 0.6	DISC BRUSH øDf=485mm øDe=508mm (COLOUR: WHITE)
	404653	1	PPL 0.9	DISC BRUSH øDf=485mm øDe=508mm (COLOUR: BLACK)
	405632	1	TYNEX	DISC BRUSH øDf=485mm øDe=508mm
	449908	1	TAMPICO	DISC BRUSH øDf=485mm øDe=508mm
	405527	1	-	BRUSH PAD HOLDER øDf=497mm WITH CENTER LOCK

DISPOSAL

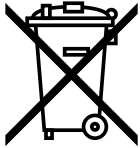

Dispose of the machine in accordance with the waste disposal regulations in force in the country in which the machine is being used.

TROUBLESHOOTING

This chapter lists the most common problems linked with the use of the machine. If you are unable to resolve the problems with the information given here, please contact your nearest assistance centre.

PROBLEM	POSSIBLE CAUSE	SOLUTION
THE MACHINE DOES NOT START	The main switch is set to "0".	Make sure the main switch is on "I". If it isn't, turn the key clockwise.
	Check that when switched on there are no alarm messages on the command display.	Stop the machine immediately, and contact a specialised service centre.
	Make sure that the batteries are correctly connected to each other and that the battery connector is connected to the electrical system connector.	Connect the batteries correctly inside the machine (see INSERTING THE BATTERIES IN THE MACHINE).
	Check the charge level of the batteries.	If the battery charge level is critical, perform a complete recharge cycle (see paragraph CHARGING THE BATTERIES).
THE BATTERIES ARE NOT CHARGED CORRECTLY (VERSIONS WITH AN ON BOARD BATTERY CHARGER)	The plug on the battery charger's cable is not correctly inserted into the socket on the battery charger itself.	Reconnect the battery charger's power cable.
	The plug on the battery charger's power cable is not correctly inserted into the electrical outlet.	Check that the battery charger power supply cable plug is connected to the mains socket.
	The characteristics of the mains power supply do not correspond to those required by the battery charger.	Check that the characteristics in the battery charger plate are the same as those of the mains supply.
	The LEDs of the battery charger blink repeatedly.	Referring to the battery charger use and maintenance manual, check the meaning of the flashing signals that the battery charger emits during the battery recharge stage.
THE MACHINE HAS A VERY LOW WORK AUTONOMY	Check the battery charge level, check the symbol on the command display.	If the battery charge level is critical, perform a complete recharge cycle (see RECHARGING THE BATTERIES).
THE MACHINE DOES NOT MOVE	The machine does not start.	Read the section "THE MACHINE DOES NOT START" .

PROBLEM	POSSIBLE CAUSE	SOLUTION
NOT ENOUGH DETERGENT SOLUTION ON THE BRUSH	The quantity of detergent solution in the water system is not sufficient for the work to be carried out.	Check that the amount of detergent solution present in the machine's water system is sufficient for the work to be carried out.
	Detergent solution filter obstructed.	Check the detergent solution filter isn't obstructed. If it is, clean it (see " CLEANING THE WATER SYSTEM FILTER ").
THE MACHINE DOES NOT CLEAN CORRECTLY	The machine does not start.	Read the section " THE MACHINE DOES NOT START ".
	Not enough detergent solution comes out.	Read the section " NOT ENOUGH DETERGENT SOLUTION ON THE BRUSH ".
	The brushes have not been inserted correctly in the machine.	Check that the disc brushes have been correctly inserted in the machine (see " ASSEMBLING THE BRUSH ").
	The type of brush used is not suitable for the dirt to be cleaned.	Make sure that the brushes fitted on the machine are appropriate for the task to be performed (see " BRUSHES AND BRUSH PAD HOLDER ").
	The brush bristles are excessively worn.	Check the condition of the brush, and replace it if necessary (read " REPLACING THE BRUSH ").
THE SQUEEGEE DOES NOT DRY PERFECTLY	The vacuum unit is obstructed.	Make sure the squeegee is free of obstructions (read " CLEANING THE SQUEEGEE BODY ").
		Make sure the vacuum tube is free of obstructions (see " CLEANING THE VACUUM TUBE ").
		Make sure the suction motor filter is free of obstructions (see " CLEANING THE SUCTION MOTOR FILTER ").
	The cap on the recovery tank drainage tube is not properly positioned.	Check that the cap on the recovery tank drainage tube is positioned properly.
The recovery tank lid is not positioned correctly.	Check that the recovery tank lid is properly positioned on the machine.	
EXCESSIVE FOAM PRODUCTION	The detergent being used is not suitable.	Check that a low foam detergent has been used. If necessary, add a small quantity of anti-foam liquid to the recovery tank.
	The floor is not very dirty.	Dilute the detergent more.
THE MACHINE DOES NOT VACUUM CORRECTLY	The recovery tank is full.	Empty the recovery tank (read " EMPTYING THE RECOVERY TANK ").
	The vacuum device is obstructed	Read the section " THE SQUEEGEE DOES NOT DRY PERFECTLY ".

EC DECLARATION OF CONFORMITY



The undersigned manufacturer:
COMAC-FIMAP (Shanghai) Co., Ltd.
科迈柯菲迈普（上海）机械有限公司
Through the trustee appointed under the European Community
COMAC S.p.A.
declares under its sole responsibility that the products

FLOOR SCRUBBING MACHINES **mod. Agila 40/43 Bt; Agila 40/50 Bt; Agila 50/50 Bt**

comply with the requirements of the following Directives:

- 2006/42/EC: Machinery Directive.
- 2014/30/EC: Electromagnetic compatibility directive.

They also comply with the following standards:

- EN 60335-1:2012/A11:2014
- EN 60335-2-72:2012
- EN 12100:2010
- EN 61000-6-2:2005/AC:2005
- EN 61000-6-3:2007/A1:2011/AC:2012
- EN 62233:2008/AC:2008

The person authorized to compile the technical file:

Mr. Giancarlo Ruffo
Via Maestri del Lavoro, 13
37059 Santa Maria di Zevio (VR) - ITALY
Santa Maria di Zevio (VR), 04/11/2019

Comac S.p.A.
Legal representative
Giancarlo Ruffo

Manufacturer:
COMAC-FIMAP (Shanghai) Co., Ltd.
科迈柯菲迈普（上海）机械有限公司
Building 2, No.299 Dongye road, Dongjing Town, Songjiang, Shanghai
上海市松江区洞泾镇洞业路299号2栋 201619
Website: www.comac.it; www.fimap.com

Agent:
COMAC S.p.A.
Via Maestri del Lavoro, 13
Post code/ ZIP 37059 Santa Maria di Zevio (VR) - Verona - Italy
Tel: 045 8774222 - Fax: 045 8750303
Website: www.comac.it Email: com@comac.it

The undersigned manufacturer:
COMAC-FIMAP (Shanghai) Co., Ltd.
科迈柯菲迈普（上海）机械有限公司
Through the trustee appointed under the European Community
COMAC S.p.A.
declares under its sole responsibility that the products

FLOOR SCRUBBING MACHINES
mod. Agila 40/43 Bt CB; Agila 40/50 Bt CB; Agila 50/50 Bt CB

comply with the requirements of the following Directives:

- 2006/42/EC: Machinery Directive.
- 2014/35/EU: Low Voltage Directive.
- 2014/30/EU: Electromagnetic compatibility directive.

They also comply with the following standards:

- EN 60335-1:2012/A11:2014
- EN 60335-2-72:2012
- EN 12100:2010
- EN 60335-2-29:2004/A2:2010
- EN 61000-6-2:2005/AC:2005
- EN 61000-6-3:2007/A1:2011/AC:2012
- EN 61000-3-2:2014
- EN 61000-3-3:2013
- EN 55014-1:2006/A1:2009/A2:2011
- EN 55014-2:2015
- EN 62233:2008/AC:2008

The person authorized to compile the technical file:

Mr. Giancarlo Ruffo
Via Maestri del Lavoro, 13
37059 Santa Maria di Zevio (VR) - ITALY
Santa Maria di Zevio (VR), 04/11/2019

Comac S.p.A.
Legal representative
Giancarlo Ruffo

Manufacturer:
COMAC-FIMAP (Shanghai) Co., Ltd.
科迈柯菲迈普（上海）机械有限公司
Building 2, No. 299 Dongye road, Dongjing Town, Songjiang, Shanghai
上海市松江区洞泾镇洞业路299号2栋 201619
Website: www.comac.it; www.fimap.com

Agent:
COMAC S.p.A.
Via Maestri del Lavoro, 13
Post code/ ZIP 37059 Santa Maria di Zevio (VR) - Verona - Italy
Tel: 045 8774222 - Fax: 045 8750303
Website: www.comac.it Email: com@comac.it

